

BEDFORD[®]

SPRAY EQUIPMENT PARTS

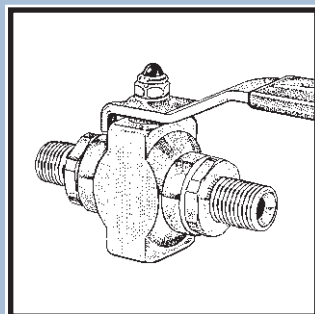
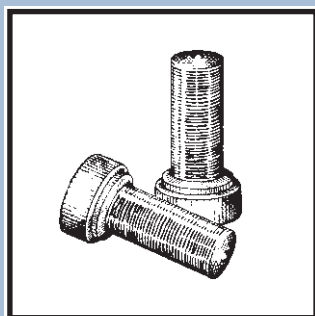
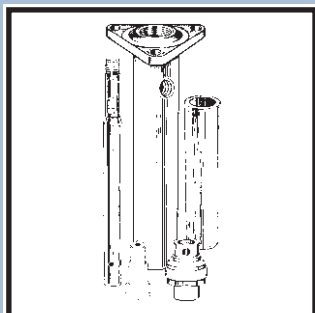
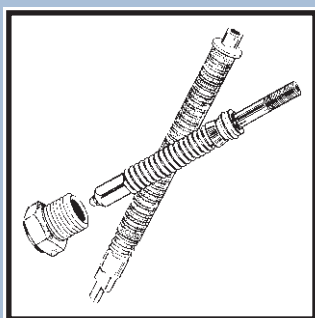

Spray Paint Equipment End-User Catalog June 2009

Parts and Components for:

- AIRLESSCO
- AMSPRAY
- ASM
- BINKS
- DEVILBISS
- GLIDDEN
- GRACO
- H.E.R.O.
- KREMLIN
- LARIUS
- SHARPE
- SPEEFLO
- TITAN
- WAGNER
- SHERWIN-WILLIAMS

Your local Bedford dealer is:

BEDFORD PRECISION PARTS CORP.
www.bedfordprecision.com

BEDFORD® Replacement Parts For . . . AIRLESSCO Equipment

To order, contact your local
Paint Spray Equipment Dealer and ask for
Genuine Bedford Replacement Parts.

Quick Reference for . . . AIRLESSCO Pumps

PUMP REPAIR KIT		USED ON THE FOLLOWING PUMP MODELS:
REPLACES AIRLESSCO PART NO.	BEDFORD PART NO.	
187-040 Complete kit with Leather/Polyethylene packing sets	20-1815	Airlessco: 3600, 3600SL, 4100, 4100SL, 5100, 5100SL, 5300, 5300SL, 5500G, 6000G, 6100, 6100DE, 6100GS, 7100, AllPro: 800E, 810E 1000E Glidden ProSpray: 808, 1000, 1300 SL Series: 8, 10, 11, 810, 1100, 3600, 4100, 5100, 5300, 6200 Surestripe: 4500, 6000
187-042 Complete kit with Teflon packing sets	20-1947	
189-376 Complete kit with Leather/Teflon packing sets	20-1816	8100, 8100GS, 9100, 9100GS
331-210 Complete kit with Leather/Polyethylene packing sets	20-1999	Little Pro (LP Series): 460, 540, 690, 2400, 2500, 2600 Power Pup: 4, 5, 6 Glidden ProSpray: 402, 404, 505, 606 All Pro: 400E, 500E, 600E

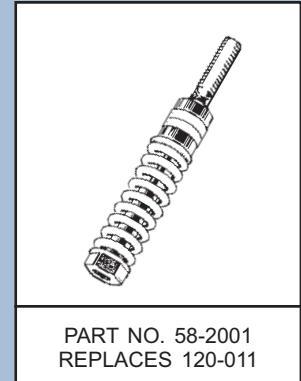

Quick Reference for . . . AIRLESSCO Spray Guns

SPRAY GUN REPAIR KIT		USED ON THE FOLLOWING SPRAY GUNS:
REPLACES AIRLESSCO PART NO.	BEDFORD PART NO.	
KIT-2-007	20-2031	007 AIRLESS SPRAY GUN Contains: Diffuser/Seat Assembly, Ball Holder, & Seals
KIT-3-007	20-2032	007 AIRLESS SPRAY GUN — also used on Marathon Prime Valve P/N 138-001 "Complete" Repair Kit - Contains: Diffuser/Seat Assembly, Ball Holder, & Valve Spring Unit with Seals

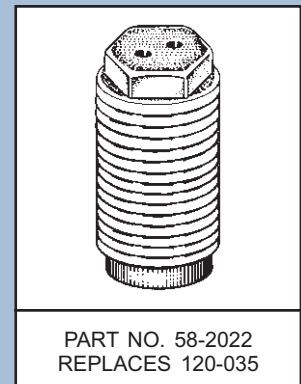

Replacement Parts for . . . AIRLESSCO

REPLACES AIRLESSCO PART NO.	BEDFORD PART NO.	DESCRIPTION	AIRLESSCO LIST PRICE (\$)
101-047	17-2238	Valve Label "OPEN-CLOSED"	—
106-009	15-1990	Teflon O-Ring	1.39
106-011	15-1998	Teflon O-Ring	4.34
106-012	15-1824	Teflon O-Ring	8.12
106-013	0-1825	O-Ring	5.93
106-014	0-1827	O-Ring	5.36
106-015	15-1832	Teflon O-Ring	2.59
106-016	0-1833	O-Ring	2.27
106-017	15-1834	Teflon O-Ring	4.77
106-018	15-1826	Teflon O-Ring	5.34
106-020	15-2052	Teflon O-Ring	4.73
106-021	15-2406	Teflon O-Ring	2.09
115-017	9-1818	Ball, 7/32", Carbide	9.87
115-022	9-1819	Ball, 5/16", Carbide	33.18
115-050	9-1820	Ball, 11/32", Carbide	32.16

AIRLESSCO LIST PRICES ARE BASED ON SINGLE UNIT PRICE IN AIRLESSCO U.S. PRICE LIST DATED 3/2/09

To order, contact your local
Paint Spray Equipment Dealer and ask for
Genuine Bedford Replacement Parts.

BEDFORD® Replacement Parts For . . . AIRLESSCO Equipment

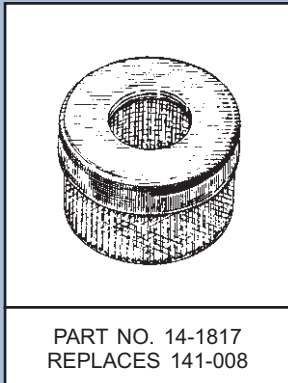
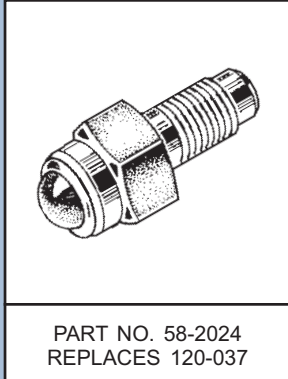

REPLACES AIRLESSCO PART NO.	BEDFORD PART NO.	DESCRIPTION	AIRLESSCO LIST PRICE (\$)
120-007	58-2239	Carbide Ball Seat	17.10
120-008	8-2018	Tip Washer	—
120-011	58-2001	Valve Spring Unit - 007 Gun	47.08
120-012	12-2025	Guide	8.57
120-013	23-2026	Spring	3.68
120-014	44-2027	Shaft	22.90
120-021	19-2007	Locknut	2.09
120-032	18-2028	Male Adapter	7.22
120-033	2-2029	Seal, Teflon	4.58
120-034	18-2030	Female Adapter	6.68
120-035	58-2022	Diffuser/Valve Seat Assembly - 007 Gun	47.44
120-037	58-2024	Ball Holder Assembly - 007 Gun	23.56
120-534	20-1502	Kit - Pro-Light Gun / Contractor Gun (Graco)	63.56
141-008	14-1817	Inlet Strainer, 3/4" NPT Thread	10.26
186-032	6-1821	Piston Seal	3.79
187-020	9-1822	Ball	8.93
187-022	17-1894	Ball Stop	5.40
187-027T	—	Replaced by 106-012 (15-1824)	—
187-027V	—	Replaced by 106-013 (0-1825)	—
187-028T	—	Replaced by 106-018 (15-1826)	—
187-028V	—	Replaced by 106-014 (0-1827)	—
187-029	49-2407	V-Packing	3.52
187-029L	—	Replaced by 187-059 (1-1828)	—
187-029T	2-1829	Teflon V-Packing	—
187-030	49-2408	V-Packing	3.64
187-030L	—	Replaced by 187-060 (1-1830)	—
187-030T	2-1831	Teflon V-Packing	—
187-033T	—	Replaced by 106-015 (15-1832)	—
187-033V	—	Replaced by 106-016 (0-1833)	—
187-034T	—	Replaced by 106-017 (15-1834)	—
187-037	18-2409	Male Adapter	17.55
187-040	20-1815	Kit - 3600, 4100, 5100, 5300, 6100 Pumps	76.38
187-042	20-1947	Kit - 3600, 4100, 5100, 5300, 6100 Pumps	—
187-058	18-2308	Female Gland	10.71
187-059	1-1828	Leather V-Packing	9.92
187-060	1-1830	Leather V-Packing	7.13
189-023P	18-1835	Female Adapter	23.56
189-028L	1-1836	Leather V-Packing	13.77
189-028T	2-1837	Teflon V-Packing	5.64
189-034T	15-1838	Teflon O-Ring	11.56
189-035T	15-1839	Teflon O-Ring	6.02
189-036T	15-1840	Teflon O-Ring	4.68
189-063	9-1841	Ball	22.41
189-376	20-1816	Kit - 8100, 9100 Pumps	178.45
331-014	18-1986	Male Adapter	2.09
331-015D	18-2277	Female Adapter, Double-Sided	—
331-016	49-1988	V-Packing	2.09
331-016L	1-1989	Leather V-Packing	—
331-020T	—	Replaced by 106-009 (15-1990)	—
331-020V	0-1991	O-Ring	—

AIRLESSCO LIST PRICES ARE BASED ON SINGLE UNIT PRICE IN AIRLESSCO U.S. PRICE LIST DATED 3/2/09

BEDFORD® Replacement Parts For . . . AIRLESSCO Equipment

To order, contact your local
Paint Spray Equipment Dealer and ask for
Genuine Bedford Replacement Parts.

Replacement Parts for . . . AIRLESSCO (continued...)

REPLACES AIRLESSCO PART NO.	BEDFORD PART NO.	DESCRIPTION	AIRLESSCO LIST PRICE (\$)
331-021	18-1992	Female Adapter	2.09
331-022	18-1993	Male Adapter	2.09
331-023	49-1994	V-Packing	2.09
331-023L	1-1995	Leather V-Packing	—
331-027	9-1996	Ball	2.09
331-030	9-1997	Ball	2.61
331-032T	—	Replaced by 106-011 (15-1998)	—
331-036T	—	Replaced by 106-020 (15-2052)	—
331-100	15-1985	Teflon O-Ring	2.09
331-105	0-2240	O-Ring	2.09
331-210	20-1999	Kit - Little Pro, Power Pup, 2400, 2500, 2600	63.23
331-211	20-2241	Kit - Prime & Pressure Relief Valve	35.31
KIT-1-007	55-2019	Tip Washers (12-pack)	—
KIT-2-007	20-2031	Ball Holder & Seal Kit - 007 Gun	61.66
KIT-3-007	20-2032	Kit - 007 Gun (Complete), Marathon Valve	71.94

AIRLESSCO LIST PRICES ARE BASED ON SINGLE UNIT PRICE IN AIRLESSCO U.S. PRICE LIST DATED 3/2/09

BEDFORD® Replacement Parts For . . . ASM Equipment

To order, contact your local
Paint Spray Equipment Dealer and ask for
Genuine Bedford Replacement Parts.

Replacement Parts for . . . ASM

REPLACES ASM PART NO.	BEDFORD PART NO.	DESCRIPTION	ASM LIST PRICE (\$)
3027-F	—	Order as: 4427-F (20-2234)	—
3027-G	—	Order as: 4427-G (20-2393)	—
4402-F	58-2232	Diffuser - 300/400 Gun (11/16 "F" Thread)	37.50
4402-G	58-2385	Diffuser - 300/400 Gun (7/8 "G" Thread)	37.50
4404	47-2227	Ball Mount & Valve Plunger Assembly	44.20
4405	47-2229	Ball Mount Assembly	21.70
4412	6-2223	External Seal	2.35
4425	55-2226	Valve Stem Locknuts (3-pack)	6.00
4426-F	20-2233	Kit - 300/400 Gun ("F" Diffuser & Ball Mount)	53.50
4426-G	20-2392	Kit - 300/400 Gun ("G" Diffuser & Ball Mount)	54.00
4427-F	20-2234	Kit - 300/400 Gun ("F" Diffuser, Ball/Plunger)	73.75
4427-G	20-2393	Kit - 300/400 Gun ("G" Diffuser, Ball/Plunger)	73.75
4428	47-2235	Valve Plunger Assembly - 300/400 Gun	29.00
4433-2	55-2721	Gun Filters, 50 Mesh, White, Medium (2-Pk)	8.15
4434-2	55-2722	Gun Filters, 100 Mesh, Yellow, Fine (2-Pk)	8.15
4435-2	55-2723	Gun Filters, 200 Mesh, Red, Extra-Fine (2-Pk)	8.15
4436-2	55-2724	Gun Filters, 30 Mesh, Green, Coarse (2-Pk)	8.15

ASM LIST PRICES ARE BASED ON SINGLE UNIT PRICE IN ASM U.S. PRICE LIST DATED 12/29/08

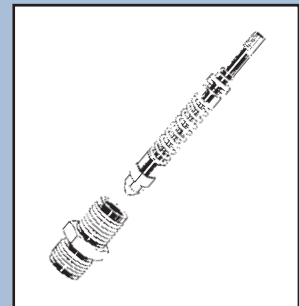

PART NO. 20-2234
REPLACES 4427-F

To order, contact your local
Paint Spray Equipment Dealer and ask for
Genuine Bedford Replacement Parts.

BEDFORD® Replacement Parts For . . . BINKS Equipment

Quick Reference for . . . BINKS Spray Guns

SPRAY GUN	REPAIR KIT		PACKING KIT		PACKING KIT (10 PACK)	
	REPLACES BINKS PART NO.	BEDFORD PART NO.	REPLACES BINKS PART NO.	BEDFORD PART NO.	REPLACES BINKS PART NO.	BEDFORD PART NO.
MODEL 7	6-188	20-324	6-213	20-317	6-216	20-1065
MODEL 18	6-189	20-328	6-214	20-318	6-217	20-1066
MODEL 62	—	—	6-163	20-1019	6-169	20-321
MODEL 69	6-195	20-329	6-185	20-322	6-186	20-761
MODEL 95	54-3577	20-2154	54-4225	20-2080	—	—
MODEL 2001	6-229	20-1175	6-231	20-1148	6-230	20-1147
MODEL 2001P	6-409	20-1501	—	—	—	—
MACH 1 / BBR	54-3605	20-1880	54-4225	20-2080	—	—
MACH 1A	54-3980	20-2340	—	—	—	—

Quick Reference for . . . BINKS Pumps

FLUID PUMP	For the Bedford Replacement Part, refer to the following Binks component part numbers:					
	PUMP REPAIR KIT	UPPER PACKING SET	LOWER PACKING SET	PISTON ROD	LOWER BALL SEAT	UPPER BALL SEAT
HUMDINGER	41-12815	41-12822	41-12823	41-12703	41-12795	41-2460
SUPER BEE	41-10320	41-10074	41-10079	41-10091	41-10275	41-10084
HORNET	41-9656	41-9614	41-9613	—	—	—
SUPER HORNET	41-9745	41-9788	41-9791	—	—	—
WASP	41-9656	41-9614	41-9613	—	—	—

NOTE: Binks part numbers that are packaged and sold as multi-packs (-K5, -K10, etc.) are listed in this catalog as the single piece component part numbers and priced as such. When ordering these parts, order by the individual piece part number in any quantity desired.

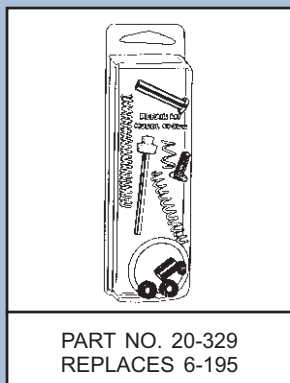

Replacement Parts for . . . BINKS

REPLACES BINKS PART NO.	BEDFORD PART NO.	DESCRIPTION	BINKS LIST PRICE (\$)
2-56	2-1842	Teflon Packing	—
6-163	20-1019	Packing Kit - #62 Gun	—
6-169	20-321	Packing Kits - #62 Gun (10-Pack)	—
6-185	20-322	Packing Kit - #69 Gun	—
6-188	20-324	Repair Kit - #7 Gun	17.25
6-189	20-328	Repair Kit - #18 Gun	—
6-195	20-329	Repair Kit - #69 Gun	—
6-213	20-317	Packing Kit - #7 Gun	—
6-214	20-318	Packing Kit - #18 Gun	—
6-216	20-1065	Packing Kits - #7 Gun (10-Pack)	—
6-217	20-1066	Packing Kits - #18 Gun (10-Pack)	—
6-229	20-1175	Repair Kit - #2001 Gun	11.75
6-230	20-1147	Packing Kits - #2001 Gun (10-Pack)	—
6-231	20-1148	Packing Kit - #2001 Gun	—
6-409	20-1501	Repair Kit - #2001P Gun	—

BINKS LIST PRICES ARE BASED ON SINGLE UNIT PRICE IN BINKS U.S. PRICE LIST DATED 12/31/08

BEDFORD® Replacement Parts For . . . BINKS Equipment

To order, contact your local
Paint Spray Equipment Dealer and ask for
Genuine Bedford Replacement Parts.

REPLACES BINKS PART NO.	BEDFORD PART NO.	DESCRIPTION	BINKS LIST PRICE (\$)
20-1544	9-179	Ball	1.20
20-2111	0-1720	O-Ring	.75
20-2194	9-252	Ball	—
20-2198	0-335	O-Ring	.70
20-2200	9-121	Ball	—
20-2227	0-1244	O-Ring	.70
20-2288-1	12-1482	Plug, 1/4" NPT with Hex Socket End	2.75
20-2606-1	19-1663	Screw	2.25
20-2630	9-611	Ball	5.50
20-2631	9-177	Ball	3.75
20-3022	0-154	O-Ring	—
20-3023	0-685	O-Ring	—
20-3157	0-1359	O-Ring	—
20-3201	0-1716	O-Ring	—
20-3236	0-1503	O-Ring	.65
20-3248	0-1715	O-Ring	4.00
20-3250	9-333	Ball	10.25
20-3276	0-1245	O-Ring	—
20-3515	0-1712	O-Ring	.80
20-3562	15-1017	Teflon O-Ring	2.50
20-3599	15-1848	Teflon O-Ring	3.25
20-3620	0-2330	O-Ring	1.50
20-3757	0-1141	O-Ring	2.00
20-3847	0-1719	O-Ring	2.75
20-3859	0-1323	O-Ring	1.25
20-3955	9-1179	Ball	14.50
20-4067	12-407	Swivel Adapter 1/2" NPT(m) x 3/8" NPS(f)	—
20-4232	9-136	Ball	5.75
20-4256	12-251	Swivel Adapter 3/8" NPT(f) x 3/8" NPS(f)	—
20-4276	12-411	Swivel Adapter 1/2" NPT(f) x 3/8" NPS(f)	—
20-4277	12-412	Swivel Adapter 1/2" NPT(f) x 1/2" NPS(f)	—
20-4278	12-413	Swivel Adapter 3/4" NPT(f) x 3/4" NPS(f)	—
20-4281	12-405	Swivel Adapter 3/8" NPT(m) x 3/8" NPS(f)	14.75
20-4283	12-465	Swivel Adapter 1/2" NPT(m) x 1/2" NPS(f)	8.50
20-4429	0-956	O-Ring	2.90
20-4445	0-1714	O-Ring	2.25
20-4455	12-408	Swivel Adapter 3/4" NPT(m) x 3/4" NPS(f)	—
20-4468	12-403	Swivel Adapter 1/4" NPT(m) x 3/8" NPS(f)	8.75
20-4511	0-2276	O-Ring	5.25
20-4564	—	Functionally equivalent to 81-307 (12-971)	—
20-4615	15-1718	Teflon O-Ring	1.15
20-4728	0-419	O-Ring	—
20-4731	6-666	Backup Ring	—
20-4962	9-659	Ball	25.00
20-4963	9-615	Ball	18.00
20-5052	0-1713	O-Ring	3.10
20-5205	0-1381	O-Ring	—
20-5285	0-1142	O-Ring	1.75
20-5286	0-2339	O-Ring	2.50
20-5430	9-137	Ball	—

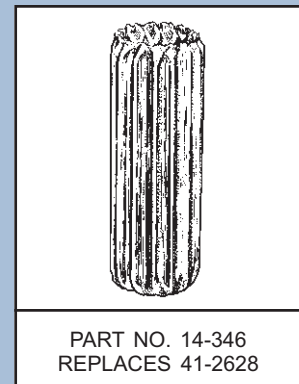
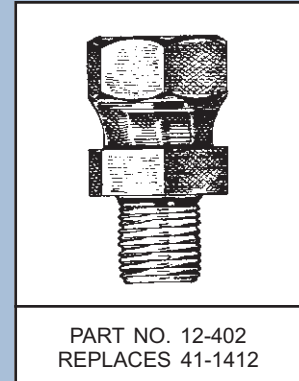

BINKS LIST PRICES ARE BASED ON SINGLE UNIT PRICE IN BINKS U.S. PRICE LIST DATED 12/31/08

To order, contact your local
Paint Spray Equipment Dealer and ask for
Genuine Bedford Replacement Parts.

BEDFORD® Replacement Parts For . . . BINKS Equipment



PART NO. 57-1000
REPLACES 41-10091

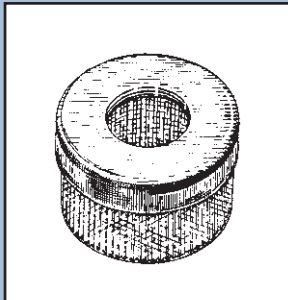

PART NO. 14-674
REPLACES 41-10094

REPLACES BINKS PART NO.	BEDFORD PART NO.	DESCRIPTION	BINKS LIST PRICE (\$)
20-5740	15-1717	Teflon O-Ring	2.30
20-6160	15-2153	Teflon O-Ring	2.00
20-6536	19-1956	Packing Removal Screw	—
41-1242	2-887	Teflon V-Packing	4.00
41-1295	10-595	Gasket	—
41-1346	1-1247	Leather V-Packing	6.75
41-1412	12-402	Swivel Adapter 1/4" NPT(m) x 1/4" NPS(f)	4.50
41-1434	2-199	Teflon V-Packing	—
41-1530	1-664	Leather V-Packing	—
41-1533	1-641	Leather V-Packing	4.00
41-1596	1-436	Leather V-Packing	—
41-1597	1-513	Leather V-Packing	—
41-1670	2-168	Teflon V-Packing	—
41-1671	2-169	Teflon V-Packing	—
41-1691	1-530	Leather V-Packing	—
41-1692	1-1262	Leather V-Packing	4.50
41-1695	2-200	Teflon V-Packing	—
41-1700	1-910	Leather V-Packing	—
41-1804	10-646	Seal	—
41-1898	1-642	Leather V-Packing	—
41-2075	2-170	Teflon V-Packing	—
41-2277	2-337	Teflon V-Packing	—
41-2421	2-338	Teflon V-Packing	—
41-2422	4-1392	Teflon Cup	—
41-2442	10-645	Gasket	—
41-2456	2-197	Teflon V-Packing	—
41-2457	2-198	Teflon V-Packing	—
41-2460	58-1891	Upper Ball Seat - Humdinger	—
41-2627	14-345	Filter Element - .006 Screen (100 Mesh)	—
41-2628	14-346	Filter Element - .009 Screen (60 Mesh)	—
41-2629	14-347	Filter Element - .012 Screen (50 Mesh)	20.00
41-2739	20-644	Packing Kit - Economy	—
41-2828	2-336	Teflon V-Packing	—
41-2854	1-665	Leather V-Packing	—
41-9613	20-1280	Lower Packing Set - Hornet / Wasp	—
41-9614	20-1281	Upper Packing Set - Hornet / Wasp	—
41-9617	10-948	Seal	—
41-9628	18-945	Male Adapter	—
41-9630	18-943	Female Adapter	—
41-9631	1-908	Leather V-Packing	—
41-9632	2-884	Teflon V-Packing	—
41-9633	18-944	Male Adapter	—
41-9634	18-946	Female Adapter	—
41-9635	1-909	Leather V-Packing	—
41-9636	2-885	Teflon V-Packing	—
41-9639	6-950	Tube Seal	—
41-9646	6-949	Valve Seal	—
41-9656	20-952	Kit - Hornet / Wasp	—
41-9695	6-1352	Seal	—
41-9712	10-332	Gasket	—

BINKS LIST PRICES ARE BASED ON SINGLE UNIT PRICE IN BINKS U.S. PRICE LIST DATED 12/31/08

BEDFORD® Replacement Parts For . . . BINKS Equipment

To order, contact your local
Paint Spray Equipment Dealer and ask for
Genuine Bedford Replacement Parts.

REPLACES BINKS PART NO.	BEDFORD PART NO.	DESCRIPTION	BINKS LIST PRICE (\$)
41-9718	10-947	Gasket	—
41-9728	18-1128	Male Adapter	—
41-9729	18-1129	Female Adapter	—
41-9731	6-1127	Tube Seal	—
41-9736	18-1130	Female Adapter	—
41-9737	1-911	Leather V-Packing	—
41-9738	2-886	Teflon V-Packing	—
41-9739	18-1131	Male Adapter	—
41-9745	20-1132	Kit - Super Hornet	—
41-9788	20-1432	Upper Packing Set - Super Hornet	—
41-9791	20-1433	Lower Packing Set - Super Hornet	—
41-10069	6-334	Gasket	—
41-10074	20-376	Upper Packing Set - Super Bee	—
41-10075	18-661	Female Adapter	—
41-10076	18-660	Male Adapter	—
41-10079	20-377	Lower Packing Set - Super Bee	—
41-10080	18-663	Female Adapter	—
41-10083	18-662	Male Adapter	—
41-10084	58-1941	Piston Seat Assembly - Super Bee	—
41-10090	10-593	Gasket	—
41-10091	57-1000	Pump Rod - Super Bee	—
41-10094	14-674	Inlet Strainer - 3/4" NPT Thread	19.75
41-10149	8-1108	Gasket	—
41-10275	58-1892	Lower Ball Seat - Super Bee	—
41-10285	20-639	Packing Set - "B"	—
41-10320	20-375	Kit - Super Bee	191.00
41-12669	1-214	Leather V-Packing	—
41-12703	57-1462	Rod - Humdinger	—
41-12711	18-326	Male Adapter	—
41-12715	18-532	Male Adapter	—
41-12718	8-1070	Gasket	—
41-12720	8-1069	Gasket	—
41-12722	8-1067	Gasket	—
41-12795	58-1893	Lower Ball Seat - Humdinger	—
41-12815	20-1092	Kit - Humdinger	—
41-12818	18-210	Female Adapter	—
41-12819	18-213	Female Adapter	—
41-12820	2-220	Teflon V-Packing	—
41-12821	2-531	Teflon V-Packing	—
41-12822	20-533	Upper Packing Set - Humdinger	—
41-12823	20-566	Lower Packing Set - Humdinger	—
54-304	23-777	Spring	1.60
54-722	7-1052	Wiper Cup	1.45
54-723	10-745	Gasket	.75
54-728	23-775	Spring	1.45
54-736	23-779	Spring	—
54-738	7-778	Packing	.65
54-739	8-182	Gasket	3.25
54-744	47-363	Stem	7.75
54-747	7-755	Packing	.65

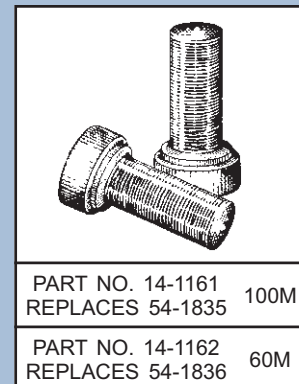

BINKS LIST PRICES ARE BASED ON SINGLE UNIT PRICE IN BINKS U.S. PRICE LIST DATED 12/31/08

To order, contact your local
Paint Spray Equipment Dealer and ask for
Genuine Bedford Replacement Parts.

BEDFORD® Replacement Parts For . . . BINKS Equipment

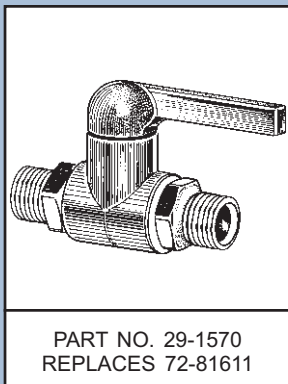
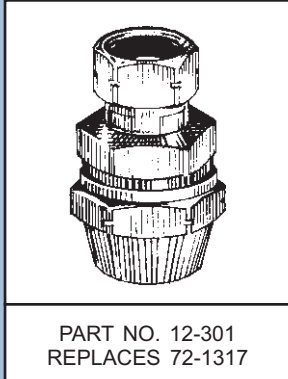

REPLACES BINKS PART NO.	BEDFORD PART NO.	DESCRIPTION	BINKS LIST PRICE (\$)
54-749	8-951	Gasket	.85
54-750	23-773	Spring	1.40
54-759	44-176	Screw	6.25
54-760	44-178	Stud	5.75
54-764	10-764	Packing, graphite	—
54-918	8-701	Gasket	1.15
54-1014	44-1045	Pin	.75
54-1020	44-215	Stud	4.25
54-1025	47-364	Stem	7.75
54-1347	23-248	Spring	1.45
54-1439	8-830	Gasket	4.75
54-1697	23-1043	Spring	2.75
54-1706	47-365	Stem	—
54-1734	44-1046	Pin	—
54-1735	7-1018	Packing	3.25
54-1835	14-1161	Tip Filter, 100 Mesh, Fine	18.25
54-1836	14-1162	Tip Filter, 60 Mesh, Coarse	18.25
54-2066	7-757	Packing	—
54-2229	8-649	Gasket	2.05
54-3512	47-1877	Spindle Assembly - Mach I / BBR	14.50
54-3518	23-1878	Spring, Blue	3.00
54-3520	23-1879	Spring, Yellow	3.50
54-3577	20-2154	Kit - Model 95 Gun	26.00
54-3605	20-1880	Kit - Mach I / BBR Gun	25.00
54-3710	10-1845	Packing Gland	—
54-3729	6-2331	Seal	3.00
54-3919	—	Order as: (1) 54-1020 & (1) 82-126	—
54-3980	20-2340	Kit - BBR & Mach 1A Automatic Guns	11.00
54-4225	20-2080	Kit - #95 Gun Fluid Inlet	7.50
54-4226	20-2155	Spindle Kit - Model 95 Gun	26.00
54-4261	20-1960	Needle Packing Kit - Mach I / BBR	6.50
54-4263	12-1959	Packing Nut	3.25
54-4264	4-1954	Adapter	3.75
54-4265	4-1955	Needle Seal	3.00
54-4266	10-1957	Seal, Backup	3.00
54-4267	23-1958	Spring	3.25
55-30	54-29	Cup Lid Gasket	2.25
56-730	54-32	Cup Lid Gasket	—
58-266	44-174	Stud, Trigger	—
71-28	12-227	Brass Nipple 1/8" NPT x 1/4" NPS	3.25
71-130	13-64	1/4" Red Smooth Air Hose, Cut Length	1.01
71-131	13-79	5/16" Red Smooth Air Hose, Cut Length	1.19
71-132	13-66	3/8" Red Air Hose, Cut Length	1.26
71-280	13-470	1/4" Fluid Hose, Full Reel (per foot)	1.69
71-282	13-480	3/8" Fluid Hose, Full Reel (per foot)	2.04
71-283	13-1010	1/2" Fluid Hose, Full Reel (per foot)	3.15
71-1103	13-520	15' x 1/4" Air Hose Assembly	—
71-1105	13-521	25' x 1/4" Air Hose Assembly	48.50
71-1106	13-522	50' x 1/4" Air Hose Assembly	79.50
71-1107	13-523	75' x 1/4" Air Hose Assembly	—

BINKS LIST PRICES ARE BASED ON SINGLE UNIT PRICE IN BINKS U.S. PRICE LIST DATED 12/31/08

BEDFORD® Replacement Parts For . . . BINKS Equipment

To order, contact your local
Paint Spray Equipment Dealer and ask for
Genuine Bedford Replacement Parts.

REPLACES BINKS PART NO.	BEDFORD PART NO.	DESCRIPTION	BINKS LIST PRICE (\$)
71-1108	13-524	100' x 1/4" Air Hose Assembly	—
71-1203	13-366	15' x 5/16" Air Hose Assembly	33.25
71-1205	13-354	25' x 5/16" Air Hose Assembly	49.00
71-1206	13-355	50' x 5/16" Air Hose Assembly	80.75
71-1207	13-356	75' x 5/16" Air Hose Assembly	—
71-1208	13-357	100' x 5/16" Air Hose Assembly	—
71-1303	13-529	15' x 3/8" Air Hose Assembly	—
71-1305	—	Replaced by 71-1355 (13-525)	—
71-1306	—	Replaced by 71-1356 (13-526)	—
71-1307	13-527	75' x 3/8" Air Hose Assembly	—
71-1308	13-528	100' x 3/8" Air Hose Assembly	—
71-1355	13-525	25' x 3/8" Air Hose Assembly	54.75
71-1356	13-526	50' x 3/8" Air Hose Assembly	102.00
71-3302	13-485	15' x 3/8" Fluid Hose Assembly	—
71-3303	13-481	25' x 3/8" Fluid Hose Assembly	76.50
71-3304	13-482	50' x 3/8" Fluid Hose Assembly	138.00
71-3305	13-483	75' x 3/8" Fluid Hose Assembly	—
71-3306	13-484	100' x 3/8" Fluid Hose Assembly	—
71-3322	13-1015	15' x 1/2" Fluid Hose Assembly	—
71-3323	13-1011	25' x 1/2" Fluid Hose Assembly	—
71-3324	13-1012	50' x 1/2" Fluid Hose Assembly	—
71-3325	13-1013	75' x 1/2" Fluid Hose Assembly	—
71-3326	13-1014	100' x 1/2" Fluid Hose Assembly	—
71-3382	13-475	15' x 1/4" Fluid Hose Assembly	—
71-3383	13-471	25' x 1/4" Fluid Hose Assembly	64.75
71-3384	13-472	50' x 1/4" Fluid Hose Assembly	124.00
71-3385	13-473	75' x 1/4" Fluid Hose Assembly	—
71-3386	13-474	100' x 1/4" Fluid Hose Assembly	—
71-7704	13-931	25' x 1/4" Airless Hose Assembly	92.00
71-7705	13-932	50' x 1/4" Airless Hose Assembly	—
71-8085	13-798	5' x 3/16" Airless Hose Assembly	—
71-8086	13-794	10' x 3/16" Airless Hose Assembly	—
71-8087	13-795	15' x 3/16" Airless Hose Assembly	—
71-8088	13-796	25' x 3/16" Airless Hose Assembly	—
71-8089	13-797	50' x 3/16" Airless Hose Assembly	—
71-8424	13-451	25' x 3/8" Airless Hose Assembly	—
71-8425	13-453	50' x 3/8" Airless Hose Assembly	282.00
71-9130	—	Replaced by 71-10000 (13-4)	—
71-9131	—	Replaced by 71-11000 (13-59)	—
71-9132	—	Replaced by 71-12000 (13-6)	—
71-9280	—	Replaced by 71-280 (13-470)	—
71-9282	—	Replaced by 71-282 (13-480)	—
71-9283	—	Replaced by 71-283 (13-1010)	—
71-9284	—	Replaced by 71-284 (13-490)	—
71-10000	13-4	1/4" Red Air Hose, Full Reel (per foot)	1.01
71-11000	13-59	5/16" Red Smooth Air Hose, Full Reel (per ft)	1.19
71-12000	13-6	3/8" Red Smooth Air Hose, Full Reel (per ft)	1.26
72-54	12-1225	Adapter 3/8" NPS(m) x 1/4" NPS(f)	—
72-55	12-599	Adapter 1/4" NPS(m) x 3/8" NPS(f)	—
72-918	12-201	Swivel Adapter 1/4" NPT(f) x 1/4" NPS(f)	12.00

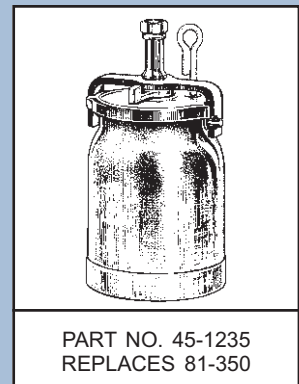
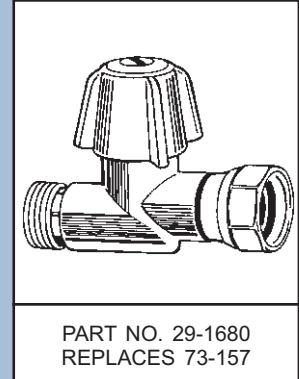

BINKS LIST PRICES ARE BASED ON SINGLE UNIT PRICE IN BINKS U.S. PRICE LIST DATED 12/31/08

To order, contact your local
Paint Spray Equipment Dealer and ask for
Genuine Bedford Replacement Parts.

BEDFORD® Replacement Parts For . . . BINKS Equipment

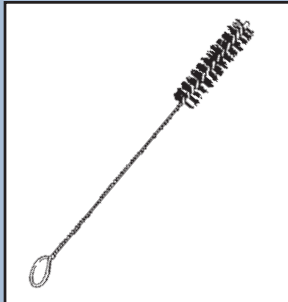

PART NO. 53-1101
REPLACES 82-469

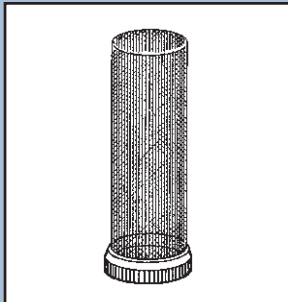

PART NO. 14-1734
REPLACES 83-1256

REPLACES BINKS PART NO.	BEDFORD PART NO.	DESCRIPTION	BINKS LIST PRICE (\$)
72-945	12-406	Swivel Adapter 3/8" NPT(m) x 1/2" NPS(f)	—
72-995	12-229	Nipple 1/4" NPT x 3/8" NPT	—
72-1303	12-304	1/4" Hose Fitting x 1/4" NPS(f)	4.00
72-1306	12-306	1/4" Hose Fitting x 3/8" NPS(f)	4.25
72-1317	12-301	5/16" Hose Fitting x 1/4" NPS(f)	4.50
72-1325	12-303	3/8" Hose Fitting x 1/4" NPS(f)	5.50
72-1328	12-302	3/8" Hose Fitting x 3/8" NPS(f)	5.50
72-1333	12-368	1/2" Hose Fitting x 3/8" NPS(f)	11.75
72-1478	12-305	5/16" Hose Fitting x 1/4" NPT(m)	5.75
72-81212	29-2375	Ball Valve, 3/8" NPT x 3/8" NPT, 250 PSI	—
72-81216	29-1693	Ball Valve, 3/8" NPT x 1/4" NPS, 250 PSI	—
72-81611	29-1570	Ball Valve, 1/4" NPS x 1/4" NPT, 250 PSI	—
72-81612	29-1672	Ball Valve, 1/4" NPS x 3/8" NPT, 250 PSI	—
72-81711	29-1694	Ball Valve, 3/8" NPS x 1/4" NPT, 250 PSI	—
72-81712	29-1571	Ball Valve, 3/8" NPS x 3/8" NPT, 250 PSI	—
72-83030	29-2575	Ball Valve, 1/4" NPT x 1/4" NPT, 250 PSI	38.75
72-84030	29-2601	Ball Valve, 1/4" NPT x 3/8" NPT, 250 PSI	48.25
72-84040	29-2576	Ball Valve, 3/8" NPT x 3/8" NPT, 250 PSI	38.75
73-9	7-1384	Gasket	.70
73-42	47-1664	Body Assembly	—
73-43	44-1665	Stem	—
73-44	12-1666	Nut	—
73-46	46-1669	Cap	—
73-157	29-1680	Metering ("Cheater") Valve	—
80-11	54-81	Cup Lid Gasket, White Plastic	2.95
80-45	54-45	Cup Gasket, Leather	—
81-304	13-918	Tube	—
81-307	12-971	Connector, Nylon	—
81-350	45-1235	Cup Assembly - Non-Drip	—
81-352	47-1232	Centerpost	39.75
81-354	46-1228	Lever	9.00
81-355	46-1229	Cover	—
81-357	17-1231	Yoke	11.50
81-550	45-1255	Cup Assembly - Standard	—
81-552	44-1227	Vent	—
82-47	45-899	Quart Cup	18.25
82-55	44-912	Nut	2.50
82-56	54-56	1-Quart Cup Lid Gasket, Thiokol	—
82-56-F	54-55	1-Quart Cup Lid Gasket, White Foam	2.25
82-126	44-175	Screw	1.60
82-158	7-749	Packing	.65
82-368	8-1226	Washer, Nylon	1.70
82-467	54-7	Gasket	1.50
82-469	53-1101	Round Brush, 9/16"	3.00
83-576	12-222	Brass Nipple 1/4" NPS x 1/4" NPT	—
83-1050	12-221	Brass Nipple 1/4" NPS x 1/4" NPS	—
83-1256	14-1734	Filter Element, 100 Mesh	8.00
83-1294	12-223	Brass Nipple 3/8" NPS x 3/8" NPS	6.25
83-1419	56-90	Tank Lid Gasket, 2 Gallon, Stratoprene	21.25
83-1419-T	56-19	Tank Lid Gasket, 2 Gallon, Thiokol	—

BINKS LIST PRICES ARE BASED ON SINGLE UNIT PRICE IN BINKS U.S. PRICE LIST DATED 12/31/08

BEDFORD® Replacement Parts For . . . BINKS Equipment

To order, contact your local
Paint Spray Equipment Dealer and ask for
Genuine Bedford Replacement Parts.

Replacement Parts for . . . Binks (continued)

REPLACES BINKS PART NO.	BEDFORD PART NO.	DESCRIPTION	BINKS LIST PRICE (\$)
83-1420	56-91	Tank Lid Gasket, 5 Gallon, Stratoprene	36.00
83-1421	56-92	Tank Lid Gasket, 10 & 15 Gallon, Stratoprene	45.25
83-1876	29-1676	ASME Air Relief Safety Valve - 80 PSI	—
83-1879	29-941	Air Safety Valve - 110 PSI	—
83-1935	12-409	Swivel Adapter 1/4" NPT(f) x 1/4" NPS(f)	11.50
83-2089	14-1732	Filter Element, 50 Mesh	10.00
83-2405	14-1735	Filter Element, 150 Mesh	14.50
83-2429	29-1677	ASME Air Relief Safety Valve - 80 PSI	50.75
83-2596	14-1733	Filter Element, 80 Mesh	15.00
83-2600	6-982	Teflon Seal	—
83-2621	20-1601	1/4" NPS(m) Fitting for Ball Valve	—
83-2622	20-1602	3/8" NPS(m) Fitting for Ball Valve	—
83-2623	20-1603	1/4" NPT(m) Fitting for Ball Valve	—
83-2635	20-1604	3/8" NPT(m) Fitting for Ball Valve	—
83-2705	14-1731	Filter Element, 30 Mesh	15.75
83-2706	14-1736	Filter Element, 200 Mesh	16.00
83-2727	28-759	Gauge, 0-100 PSI (Functionally equal)	19.50
85-53	23-1044	Spring	—
85-70	28-1358	Gauge, 1/8" NPT Btm Mnt, 0-60 PSI, 1-1/2"	19.75
86-558	12-1481	Plug, 1/4" NPT	3.00
101-1147	10-1390	Washer	4.75
101-6509	2-1016	Teflon V-Packing	—

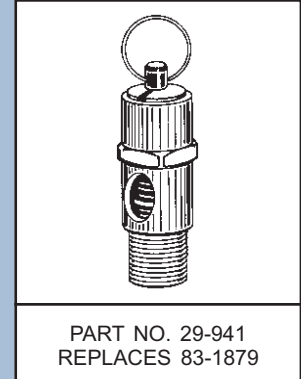

BINKS LIST PRICES ARE BASED ON SINGLE UNIT PRICE IN BINKS U.S. PRICE LIST DATED 12/31/08

BEDFORD® Replacement Parts For . . . DEVILBISS Equipment

To order, contact your local
Paint Spray Equipment Dealer and ask for
Genuine Bedford Replacement Parts.

Quick Reference for . . . DEVILBISS Spray Guns

SPRAY GUN	REPAIR KIT	
	REPLACES DEVILBISS PART NO.	BEDFORD PART NO.
JGHV (HVLV)	KK-4911	20-1596
JGA / JGV / JGK / JGP / JGPV GFG / LMG / LMK / MSA / MSV / PGA	KK-4987-2	20-2055
MBC	KK-4058-1	20-1146

To order, contact your local
Paint Spray Equipment Dealer and ask for
Genuine Bedford Replacement Parts.

BEDFORD® Replacement Parts For . . . DEVILBISS Equipment

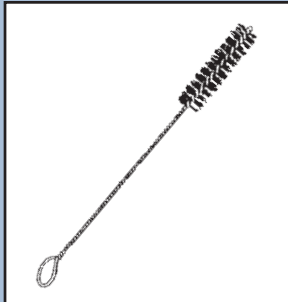

PART NO. 55-1177
REPLACES 42884-215-K10

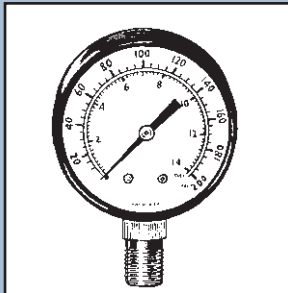

PART NO. 28-719
REPLACES GA-211

REPLACES DEVILBISS PART NO.	BEDFORD PART NO.	DESCRIPTION	DEVILBISS LIST PRICE (\$)
23165-001-K10	55-2349	O-Rings (Kit of 10)	—
42884-214-K5	55-1176	Cleaning Brushes, 3/8" Dia (Kit of 5)	16.50
42884-215-K10	55-1177	Cleaning Brushes, 5/8" Dia (Kit of 10)	29.50
A-23-K10	55-1906	Packings (Kit of 10)	17.00
A-42-K5	55-367	Screws (Kit of 5)	—
AD-31	12-221	Brass Nipple 1/4" NPS x 1/4" NPS	—
AD-404	12-599	Adapter 1/4" NPS(m) x 3/8" NPS(f)	—
AV-1-K5	55-1048	Gaskets (Kit of 5)	6.25
C-39-K5	55-71	Cup Gaskets (Kit of 5)	—
CV-5-K5	55-1055	Gaskets (Kit of 5)	7.75
GA-92	28-1358	Gauge, 1/8" NPT Btm Mnt, 0-60 PSI, 1-1/2"	—
GA-100	—	Functionally Equivalent to GA-333 Gauge	—
GA-211	28-719	Gauge, 1/4" NPT Btm Mnt, 0-200 PSI, 2"	—
GA-288	28-766	Gauge, 1/4" NPT Btm Mnt, 0-160 PSI, 2"	19.75
GA-316	28-705	Gauge, 1/4" NPT Rear Mnt, 0-160 PSI, 2"	—
GA-333	28-759	Gauge, 1/4" NPT Btm Mnt, 0-100 PSI, 2"	—
GC-25-K5	55-76	Cup Gaskets (Kit of 5)	—
H-77	12-879	Brass Nipple 3/8" NPS x 5/8"-18	—
H-153	12-878	Brass Nipple 1/4" NPS x 5/8"-18	—
H-1446	12-223	Brass Nipple 3/8" NPS x 3/8" NPS	—
H-1766	12-227	Brass Nipple 1/8" NPT x 1/4" NPS	—
H-1901	—	Replaced by Binks 71-11000 (13-59)	—
H-1921	—	Replaced by Binks 71-11000 (13-59)	—
H-1957	—	Replaced by Binks 71-10000 (13-4)	—
H-1958	—	Replaced by Binks 71-12000 (13-6)	—
H-1973-1	—	Replaced by Binks 71-282 (13-480)	—
H-1974-1	—	Replaced by Binks 71-283 (13-1010)	—
H-1975-1	—	Replaced by Binks 71-280 (13-470)	—
H-2008	12-222	Brass Nipple 1/4" NPS x 1/4" NPT	5.00
H-4326	12-413	Swivel Adapter 3/8" NPT(f) x 3/8" NPS(f)	—
HA-0125	13-358	25' x 5/16" Air Hose Assembly (Corrugated)	—
HA-0150	13-359	50' x 5/16" Air Hose Assembly (Corrugated)	—
HA-2125	13-354	25' x 5/16" Air Hose Assembly (Smooth)	—
HA-2150	13-355	50' x 5/16" Air Hose Assembly (Smooth)	—
HA-7325	13-481	25' x 3/8" Fluid Hose Assembly	—
HA-7350	13-482	50' x 3/8" Fluid Hose Assembly	—
HA-7525	13-471	25' x 1/4" Fluid Hose Assembly	—
HAR-502	26-2328	Regulator, 1/4" for Series Installations	—
HAR-505	26-1125	Regulator, 1/4" General Purpose	—
HAR-555	26-1119	Regulator, 3/8" x 1/2" for Series Installations	76.25
JGA-7-K5	—	Replaced by JGA-4035-K5 (55-2355)	—
JGA-14-K25	55-2350	Snap Rings (Kit of 25)	61.25
JGA-15-K25	55-2354	Washers (Kit of 25)	30.75
JGA-35-K5	55-1098	Trigger Bearing Studs (Kit of 5)	—
JGA-4035-K5	55-2355	Valve Packings (Kit of 5 Sets)	20.00
JGD-14-K10	55-1908	Gaskets (Kit of 10)	16.50
JGHV-116-K5	55-1963	Gaskets (Kit of 5)	—
JGS-26-K5	55-1139	U-Cups (Kit of 5)	22.10
JGS-35	—	See JGS-478 Kit (20-2268)	—
JGS-72-K10	55-913	Gaskets (Kit of 10)	12.50
JGS-431-K25	55-2356	Air Valve Assembly (Kit of 25)	202.25
JGS-449-1	20-1786	Air Valve Assembly	33.00
JGS-478	20-2268	Kit - (3) Trigger Studs & (5) Screws	19.75
KK-4058-1	20-1146	Kit - MBC Spray Gun	39.50
KK-4059	—	Replaced by KK-4987-2 (20-2055)	—

DEVILBISS LIST PRICES ARE BASED ON SINGLE UNIT PRICE IN DEVILBISS U.S. PRICE LIST DATED 12/31/08

BEDFORD® Replacement Parts For . . . DEVILBISS Equipment

To order, contact your local
Paint Spray Equipment Dealer and ask for
Genuine Bedford Replacement Parts.

REPLACES DEVILBISS PART NO.	BEDFORD PART NO.	DESCRIPTION	DEVILBISS LIST PRICE (\$)
KK-4138	24-1024	T-Handle & Cage - Gen'l Purpose Regulator	25.00
KK-4139	—	Functionally equivalent to KK-4167	—
KK-4167	24-1126	Repair Kit for General Purpose Regulators	—
KK-4830	—	Replaced by KK-4987-2 (20-2055)	—
KK-4911	20-1596	Kit - HVLP Spray Gun	—
KK-4987-2	20-2055	Kit - JGA, JGV, JGP, JGPV, MSA, MSV	27.00
KR-11-K5	55-74	Cup Gaskets (Kit of 5)	—
KR-69-K5	55-72	Cup Gaskets (Kit of 5)	—
MB-16	44-1091	Stud, Trigger Bearing	—
MB-26-K5	55-1134	Packings (Kit of 5)	—
MB-135-K9	55-1159	Needle Valve Packings (Kit of 9)	9.25
MBC-28-K5	55-902	Springs (Kit of 5)	—
MBC-29-K5	55-895	Springs (Kit of 5)	12.25
MBC-62-K5	55-1135	Packings (Kit of 5)	—
MBC-70-K2	55-1136	Needle Springs (Kit of 2)	10.00
MBC-1226-K10	55-1097	Gaskets (Kit of 10)	20.50
MBD-12-K25	55-2357	Springs (Kit of 25)	56.25
MBD-14-K10	55-1152	Packing Washers (Kit of 10)	—
MBD-19-K10	55-1909	Springs (Kit of 10)	22.25
MBD-25-K5	55-1172	Springs (Kit of 5)	—
MSV-3-K10	55-2259	Fluid Inlet Gaskets (Kit of 10)	15.75
P-H-4105	12-1225	Adapter 3/8" NPS(m) x 1/4" NPS(f)	4.25
P-H-5516	29-1680	Functionally Equivalent to Binks 73-157	35.25
P-HC-4523	12-304	1/4" Hose Fitting x 1/4" NPS(f)	—
P-HC-4527	12-301	5/16" Hose Fitting x 1/4" NPS(f)	—
P-HC-4528	12-303	3/8" Hose Fitting x 1/4" NPS(f)	—
P-HC-4543	12-306	1/4" Hose Fitting x 3/8" NPS(f)	—
P-HC-4548	12-302	3/8" Hose Fitting x 3/8" NPS(f)	—
P-HC-4551	12-368	1/2" Hose Fitting x 3/8" NPS(f)	—
P-HC-4599	12-305	5/16" Hose Fitting x 1/4" NPT(m)	5.00
PT-33-1	56-97	Tank Lid Gasket, 2-1/2 Gallon, Stratoprene	17.75
QM-1458-1	56-98	Tank Lid Gasket, 5 & 15 Gallon, Stratoprene	32.25
QM-1462	56-93	Tank Lid Gasket, 2 Gallon, Stratoprene	—
QMS-67	56-94	Tank Lid Gasket, 2 Gallon, Stratoprene	—
QMS-80-1	56-95	Tank Lid Gasket, 2-1/2 Gallon, Stratoprene	34.00
QN-96	56-96	Tank Lid Gasket, 2 Gallon, Rubber	—
QS-100	10-1652	Oil Seal	—
SS-1215	12-1480	Plug, 1/8" NPT	—
SS-1216	12-1481	Plug, 1/4" NPT	—
SS-1217	12-1483	Plug, 3/8" NPT	—
SS-7312-K5	55-1164	Gaskets (Kit of 5)	—
SSG-8020-K5	55-1182	O-Rings (Kit of 5)	—
SSG-8069-K25	55-2358	O-Rings (Kit of 25)	30.75
SSG-8182-K5	55-1961	O-Rings (Kit of 5)	5.50
SSP-3-CD	12-465	Swivel Adapter, 1/2" NPT(m) x 1/2" NPS(f)	—
SSP-7-CD	12-405	Swivel Adapter, 3/8" NPT(m) x 3/8" NPS(f)	—
SSP-14-CD	12-403	Swivel Adapter, 1/4" NPT(m) x 3/8" NPS(f)	—
SSP-25-CD	12-404	Swivel Adapter, 3/8" NPT(m) x 1/4" NPS(f)	—
SST-8405-K5	55-1140	Retaining Rings (Kit of 5)	—
SST-8434	19-1741	Retaining Ring	—
TGC-9-K5	55-87	Gaskets (Kit of 5)	16.75
TIA-5080	29-1676	ASME Air Relief Safety Valve - 80 PSI	31.75
TIA-5110	29-941	ASME Air Relief Safety Valve - 110 PSI	30.75

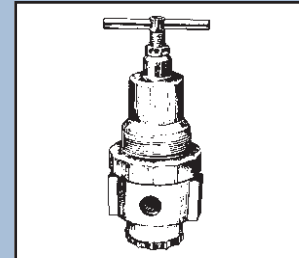

PART NO. 26-2328
REPLACES HAR-502

PART NO. 26-1125
REPLACES HAR-505

PART NO. 26-1119
REPLACES HAR-555

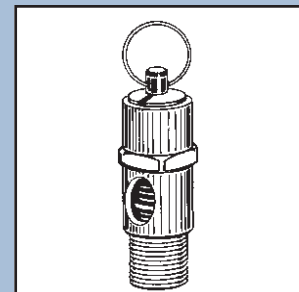

PART NO. 29-941
REPLACES TIA-5110

DEVILBISS LIST PRICES ARE BASED ON SINGLE UNIT PRICE IN DEVILBISS U.S. PRICE LIST DATED 12/31/08

To order, contact your local
Paint Spray Equipment Dealer and ask for
Genuine Bedford Replacement Parts.

BEDFORD® Replacement Parts For . . . GLIDDEN Equipment

Quick Reference for . . . GLIDDEN Pumps Private Labeled by AMSPRAY

PUMP MODEL	COMPONENT DESCRIPTION	REPLACES AMSPRAY PART NO.	BEDFORD PART NO.
500 (Non-Sleeved Fluid Sections)	Repair Kit	4235	20-1783
	Rod	191	57-1391
	Cylinder	299	57-1431
	Piston Valve	186	58-1737
	Intake Valve	205	58-1709
500 (Sleeved Fluid Sections)	Repair Kit	4235	20-1783
	Rod	181	57-1950
	Sleeve	289	57-1901
	Piston Valve	186	58-1737
750 (Non-Sleeved Fluid Sections)	Repair Kit	4235	20-1783
	Rod	19206	57-1514
	Piston Valve	186	58-1737
	Intake Valve	205	58-1709
FORMULA I	Repair Kit	4239	20-1784
SPRINT (Non-Sleeved Fluid Sections)	Repair Kit	4235	20-1783
	Rod	191	57-1391
	Cylinder	299	57-1431
	Piston Valve	186	58-1737
	Intake Valve	205	58-1709
SPRINT (Sleeved Fluid Sections)	Repair Kit	4235	20-1783
	Rod	181	57-1950
	Sleeve	289	57-1901
	Piston Valve	186	58-1737

FOR OTHER AMSPRAY REPLACEMENT REPAIR PARTS,
REFER TO PAGES 58-63

Quick Reference for . . . GLIDDEN Pumps Private Labeled by WAGNER

PUMP MODEL	COMPONENT DESCRIPTION	REPLACES WAGNER PART NO.	BEDFORD PART NO.
400 SE	Repair Kit	294904	20-2065
500 SE	Repair Kit	294905	20-2066
750 SE	Repair Kit	279910	20-2263
1000 SE	Repair Kit	294920	20-2237

FOR OTHER WAGNER REPLACEMENT REPAIR PARTS,
REFER TO PAGES 58-63

Quick Reference for . . . GLIDDEN Pumps Private Labeled by AIRLESSCO

PUMP MODEL	COMPONENT DESCRIPTION	REPLACES AIRLESSCO PART NO.	BEDFORD PART NO.
ProSpray 402, 404, 505 & 606	Repair Kit	331-210	20-1999
ProSpray 808, 1000 & 1300	Repair Kit (Standard Kit)	187-040	20-1815
	Repair Kit (All Teflon Kit)	187-042	20-1947

FOR OTHER AIRLESSCO REPLACEMENT REPAIR PARTS,
REFER TO PAGES 4-6

BEDFORD® Replacement Parts For . . . GRACO Equipment

To order, contact your local
Paint Spray Equipment Dealer and ask for
Genuine Bedford Replacement Parts.

Quick Reference for . . . GRACO Pumps

PUMP MODEL	COMPONENT DESCRIPTIONS	REPLACES GRACO PART NO.	BEDFORD PART NO.	NOTES
190 ES	Repair Kit	243-091	20-2359	Leather & polyethylene
	Piston Valve	218-197	58-1461	
	Cylinder	235-708	57-2099	Stainless steel
	Intake Valve	224-966	58-2215	
	Pressure Return Hose	241-926	13-2632	
	Drain Valve Repair Kit	235-014	20-2324	1/4-turn valve
290 Easy 390st 390sts	Repair Kit	235-703	20-1856	Leather & polyethylene
	Rod	187-613	57-1948	Stainless steel
		235-709	57-1946	Chrome plated stainless steel
	Piston Valve	224-808	58-2212	
	Cylinder	236-786	57-2131	Stainless steel
	Intake Valve	224-966	58-2215	
	Pressure Transducer	235-009	47-2370	
	Drain Valve Repair Kit	235-014	20-2324	1/4-turn valve
395st 450st 455st 490st 495st 590st 595st	Repair Kit	235-703	20-1856	Leather & polyethylene
	Rod	235-709	57-1946	Chrome plated stainless steel
	Piston Valve	218-197	58-1461	
	Cylinder	235-708	57-2099	Stainless steel
	Intake Valve	224-966	58-2215	
	Pressure Transducer	235-009	47-2370	
	Drain Valve Repair Kit	235-014	20-2324	1/4-turn valve
	295st, 395st Pro, 455st Pro, 495st Pro	Repair Kit	244-194	20-2428
Piston Valve		243-181	58-2570	
Intake Valve		243-190	20-2561	Ball, seat, o-ring & spacer
Pressure Return Hose		241-926	13-2632	
Drain Valve Repair Kit		235-014	20-2324	1/4-turn valve
Air Motor Repair Kit		206-734	20-631	7" Bulldog air motor
5:1 BULLDOG	Air Motor Repair Kit	206-734	20-631	7" Bulldog air motor
	Air Motor Trip Rod	214-852	47-1662	7" Bulldog air motor
10:1 BULLDOG	Repair Kit	206-933	20-315	Rubber
		206-934	20-806	Rubber & polyethylene
		207-581	20-999	Teflon
		207-729	20-983	Leather & Teflon
	Air Motor Repair Kit	206-734	20-631	7" Bulldog air motor
	Air Motor Trip Rod	214-852	47-1662	7" Bulldog air motor
20:1 BULLDOG	Repair Kit	207-966	20-855	Leather & Teflon; Balls ordered separately
		215-496	20-1181	Teflon conversion, Balls ordered separately
		220-395	20-1355	Leather & polyethylene
		210-539	20-1268	Polyurethane; For priming piston pump only
	Rod	178-888	57-1408	Chrome plated stainless steel
	Piston Valve	207-472	58-1769	
	Sleeve	178-894	57-1409	Chrome plated stainless steel
	Intake Valve	207-473	58-2006	
	Air Motor Repair Kit	206-734	20-631	7" Bulldog air motor
	Air Motor Trip Rod	214-852	47-1662	7" Bulldog air motor
25:1 BULLDOG	Air Motor Repair Kit	206-734	20-631	7" Bulldog air motor
	Air Motor Trip Rod	214-852	47-1662	7" Bulldog air motor
30:1 BULLDOG	Repair Kit	206-735	20-381	Leather & Teflon
		207-851	20-643	Teflon
		220-399	20-1328	Leather & polyethylene
	Rod	178-899	57-1406	Chrome plated stainless steel
	Piston Valve	205-516	58-1768	
	Sleeve	178-900	57-1407	Chrome plated stainless steel
	Intake Valve	217-476	58-2009	
	Air Motor Repair Kit	206-734	20-631	7" Bulldog air motor
Air Motor Trip Rod	214-852	47-1662	7" Bulldog air motor	
33:1 BULLDOG DURA-FLO 750	Repair Kit	237-239	20-2294	Leather & Teflon
		237-241	20-2314	Teflon
40:1 BULLDOG	Repair Kit	212-079	20-1269	Polyurethane
	Air Motor Repair Kit	206-734	20-631	7" Bulldog air motor
	Air Motor Trip Rod	214-852	47-1662	7" Bulldog air motor

To order, contact your local
Paint Spray Equipment Dealer and ask for
Genuine Bedford Replacement Parts.

BEDFORD® Replacement Parts For . . . GRACO Equipment

Quick Reference for . . . GRACO Pumps

PUMP MODEL	COMPONENT DESCRIPTIONS	REPLACES GRACO PART NO.	BEDFORD PART NO.	NOTES
55:1 BULLDOG	Air Motor Repair Kit	207-730	20-632	10" King air motor
	Air Motor Trip Rod	214-852	47-1662	10" King air motor
60:1 BULLDOG	Air Motor Repair Kit	206-734	20-631	7" Bulldog air motor
	Air Motor Trip Rod	214-852	47-1662	7" Bulldog air motor
EH 300	Repair Kit	218-135	20-1084	Leather & Teflon
		218-136	20-1114	Teflon
		223-674	20-1920	Leather & polyethylene
		235-636	20-2310	Leather, Teflon & stainless steel
		236-724	20-2311	Teflon & stainless steel
EH 333	Repair Kit	218-135	20-1084	Leather & Teflon
		218-136	20-1114	Teflon
		223-674	20-1920	Leather & polyethylene, SS
		235-636	20-2310	Leather, Teflon & stainless steel
		236-724	20-2311	Teflon & stainless steel
	Rod	207-084	—	Replaced by 223-603 (57-1402)
		223-603	57-1402	Chrome plated stainless steel
	Piston Valve	205-538	58-1581	Zinc plated carbon steel
		223-591	58-2307	Stainless steel
	Cylinder, Outlet Housing	207-420	57-1965	Carbon steel
	Sleeve	178-898	57-1403	Chrome plated stainless steel
Intake Valve	206-399	58-1582		
EH 433 EH 433 GT	Repair Kit	207-850	20-681	Teflon
		208-919	20-389	Leather & Teflon
		223-675	20-1898	Leather & polyethylene
		223-664	20-2434	Leather & polyethylene
		235-635	20-2079	Leather, Teflon & stainless steel
	Rod	223-589	57-1404	Chrome plated stainless steel
	Piston Valve	206-345	58-1584	Zinc plated carbon steel
		223-565	58-2306	Stainless steel
	Cylinder, Outlet Housing	207-420	57-1965	Carbon steel
	Sleeve	164-481	57-1005	Carbon steel
		178-902	57-1405	Chrome plated stainless steel
Intake Valve	205-981	58-1583		
EM 380 EM 390 EM 490 (non-sleeved pumps)	Repair Kit	222-587	20-1526	Leather & polyethylene
	Rod	181-879	57-1360	Carbon steel
		183-563	57-1748	Chrome plated stainless steel
	Piston Valve	218-197	58-1461	
	Cylinder	177-929	57-1435	Carbon steel
	Intake Valve	215-455	58-1585	For non-sleeved pumps only
Pressure Return Hose	223-766	13-1855	1/4"NPS(fbe) x 29"	
EM 380 EM 390 EM 490 (removable sleeved pumps)	Repair Kit	222-587	20-1526	Leather & polyethylene
	Rod	183-563	57-1748	Chrome plated stainless steel
	Piston Valve	218-197	58-1461	
	Sleeve	183-571	57-1749	Stainless steel
	Intake Valve	221-098	58-2012	For sleeved pumps only
	Pressure Return Hose	223-766	13-1855	1/4"NPS(fbe) x 29"
EM 400, EM 480	Repair Kit	208-940	20-379	Leather & Teflon
	Piston Valve	208-567	58-1460	
	Cylinder	208-371	57-1311	Carbon steel
	Pressure Return Hose	223-763	13-314	1/4"NPS(f) x 1/4"NPS(f) 90° x 15"
EM 590 (non-sleeved pumps) Note: See next grouping for removable sleeved pumps	Repair Kit	222-588	20-1499	Leather & polyethylene
	Piston Rod	222-438	57-1910	Chrome plated stainless steel
	Piston Valve	218-036	58-1775	
	Cylinder	178-949	57-1439	Carbon steel
	Intake Valve	217-574	58-1772	For non-sleeved pumps only
Pressure Return Hose	223-766	13-1855	1/4"NPS(fbe) x 29"	

BEDFORD® Replacement Parts For . . . GRACO Equipment

To order, contact your local
Paint Spray Equipment Dealer and ask for
Genuine Bedford Replacement Parts.

Quick Reference for . . . GRACO Pumps

PUMP MODEL	COMPONENT DESCRIPTIONS	REPLACES GRACO PART NO.	BEDFORD PART NO.	NOTES
EM 590 (removable sleeved pumps)	Repair Kit	222-588	20-1499	Leather & polyethylene
	Rod	222-438	57-1910	Chrome plated stainless steel
	Piston Valve	218-036	58-1775	
	Sleeve	185-213	57-1911	Stainless steel
	Cylinder, Outlet Housing	185-211	57-2423	Outer casing for sleeve
	Intake Valve	222-437	58-2014	For sleeved pumps only
	Pressure Return Hose	223-766	13-1855	1/4"NPS(fbe) x 29"
EM 5000	Repair Kit	220-877	20-1500	Leather & polyethylene
	Rod	220-630	57-1776	Chrome plated stainless steel
	Piston Valve	220-631	58-1938	
	Sleeve	183-361	57-1599	Stainless steel
	Cylinder, Outlet Housing	183-181	57-2383	Outer casing for sleeve
	Intake Valve	220-629	58-1944	
	Pressure Return Hose	220-849	12-2151	3/8"NPS(fbe) x 29"
1:1 FAST-FLO	Repair Kit	207-182	20-385	Leather & rubber; 206-285, 226-226 pumps
		207-846	20-387	Teflon; 226-337 pump
		207-847	20-371	Teflon; 205-460, 205-637 pumps
		213-012	20-1468	Leather; SI-Metric pumps
		213-013	20-1469	Teflon; SI-Metric pumps
		215-964	20-1470	Polyethylene; SI-Metric pumps
5:1 FIREBALL	Repair Kit	206-924	20-1047	Leather
	Air Motor Repair Kit	206-728	20-850	Monark air motor
		238-286	20-2690	Monark air motor & urethane pkgs
15:1 FIREBALL	Air Motor Repair Kit	206-728	20-850	Monark air motor
45:1 FIREBALL	Repair Kit	204-164	20-1617	Leather & rubber
	Air Motor Repair Kit	206-728	20-850	Monark air motor
GH 200	Repair Kit	246-341	20-2639	Leather & polyethylene
	Rod	240-919	57-2716	Chrome plated stainless steel
	Piston Valve	240-580	58-2680	
	Sleeve	240-921	57-2531	Stainless steel
GH 433	Repair Kit	207-850	20-681	Teflon
		208-919	20-389	Leather & Teflon
		223-675	20-1898	Leather & polyethylene
		235-635	20-2079	Leather, Teflon & stainless steel
	Rod	223-589	57-1404	Chrome plated stainless steel
		206-345	58-1584	Zinc plated carbon steel
	Piston Valve	223-565	58-2306	Stainless steel
		207-420	57-1965	Carbon steel
	Sleeve	164-481	57-1005	Carbon steel
		178-902	57-1405	Chrome plated stainless steel
Intake Valve	205-981	58-1583		
GH 533	Repair Kit	206-735	20-381	Leather & Teflon
		207-851	20-643	Teflon
		220-399	20-1328	Leather & polyethylene
	Rod	178-899	57-1406	Chrome plated stainless steel
	Piston Valve	205-516	58-1768	
	Sleeve	178-900	57-1407	Chrome plated stainless steel
GH 733	Repair Kit	207-966	20-855	Leather & Teflon; Balls ordered separately
		215-496	20-1181	Teflon conversion, Balls ordered separately
		220-395	20-1355	Leather & polyethylene
	Rod	178-888	57-1408	Chrome plated stainless steel
	Piston Valve	207-472	58-1769	
	Sleeve	178-894	57-1409	Chrome plated stainless steel
	Intake Valve	207-473	58-2006	
GH 833	Repair Kit	207-729	20-983	Leather & Teflon

To order, contact your local
Paint Spray Equipment Dealer and ask for
Genuine Bedford Replacement Parts.

BEDFORD® Replacement Parts For . . . GRACO Equipment

Quick Reference for . . . GRACO Pumps

PUMP MODEL	COMPONENT DESCRIPTIONS	REPLACES GRACO PART NO.	BEDFORD PART NO.	NOTES
GM 3000	Repair Kit	235-703	20-1856	Leather & polyethylene
	Rod	235-709	57-1946	Chrome plated stainless steel
	Piston Valve	218-197	58-1461	
	Cylinder	235-708	57-2099	Stainless steel
	Intake Valve	224-966	58-2215	
	Pressure Transducer	235-009	47-2370	
	Drain Valve Repair Kit	235-014	20-2324	1/4-turn valve
GM 3500 (non-sleeved pumps)	Repair Kit	222-588	20-1499	Leather & polyethylene
	Piston Rod	222-438	57-1910	Chrome plated stainless steel
	Piston Valve	218-036	58-1775	
	Cylinder	178-949	57-1439	Carbon steel
	Intake Valve	217-574	58-1772	For non-sleeved pumps only
GM 3500 (removable sleeved pumps)	Pressure Return Hose	223-766	13-1855	1/4"NPS(fbe) x 29"
	Repair Kit	222-588	20-1499	Leather & polyethylene
	Rod	222-438	57-1910	Chrome plated stainless steel
	Piston Valve	218-036	58-1775	
	Sleeve	185-213	57-1911	Stainless steel
	Cylinder, Outlet Housing	185-211	57-2423	Outer casing for sleeve
	Intake Valve	222-437	58-2014	For sleeved pumps only
GM 5000 & GM 10,000	Pressure Return Hose	223-766	13-1855	1/4"NPS(fbe) x 29"
	Repair Kit	220-877	20-1500	Leather & polyethylene
	Rod	220-630	57-1776	Chrome plated stainless steel
	Piston Valve	220-631	58-1938	
	Sleeve	183-361	57-1599	Stainless steel
	Cylinder, Outlet Housing	183-181	57-2383	Outer casing for sleeve
	Intake Valve	220-629	58-1944	
GM 7000	Pressure Return Hose	220-849	13-2151	3/8"NPS(fbe) x 29"
	Repair Kit	236-564	20-2258	Leather & polyethylene
	Rod	236-567	57-2440	Chrome plated stainless steel
	Piston Valve	236-565	58-2562	
GMAX 3900	Sleeve	236-566	57-2381	Stainless steel
	Repair Kit	248-212	20-2662	Leather & polyethylene
	Rod	240-518	57-2670	Chrome plated stainless steel
	Piston Valve	239-932	58-2564	
	Sleeve	240-521	57-2273	
	Intake Valve	239-922	20-2673	
GMAX 5900	Drain Valve Repair Kit	235-014	20-2324	1/4-turn valve
	Repair Kit	248-213	20-2663	Leather & polyethylene
	Rod	240-517	57-2672	Chrome plated stainless steel
	Piston Valve	240-150	58-2567	
	Sleeve	240-525	57-2529	
	Intake Valve	244-199	20-2713	Includes: ball seat & o-ring
GMAX 7900	Drain Valve Repair Kit	235-014	20-2324	1/4-turn valve
	Repair Kit	246-341	20-2639	Leather & polyethylene
	Rod	240-919	57-2716	Chrome plated stainless steel
	Piston Valve	240-580	58-2680	
GMAX 10,000	Sleeve	240-921	57-2531	
	Repair Kit	248-213	20-2663	Leather & polyethylene
	Rod	240-517	57-2672	Chrome plated stainless steel
	Piston Valve	240-150	58-2567	
	Sleeve	240-525	57-2529	
HYDRAMAX 225	Intake Valve	244-199	20-2713	Includes: ball seat & o-ring
	Repair Kit	246-341	20-2639	Leather & polyethylene
20:1 KING	Piston Valve	240-580	58-2680	
	Repair Kit	207-729	20-983	Leather & Teflon
	Air Motor Repair Kit	207-730	20-632	10" King air motor
	Air Motor Trip Rod	214-852	47-1662	10" King air motor

BEDFORD® Replacement Parts For . . . GRACO Equipment

To order, contact your local
Paint Spray Equipment Dealer and ask for
Genuine Bedford Replacement Parts.

Quick Reference for . . . GRACO Pumps

PUMP MODEL	COMPONENT DESCRIPTIONS	REPLACES GRACO PART NO.	BEDFORD PART NO.	NOTES
45:1 KING	Repair Kit	207-966	20-855	Leather & Teflon; Balls ordered separately
		215-496	20-1181	Teflon conversion, Balls ordered separately
		220-395	20-1355	Leather & polyethylene
	Rod	178-888	57-1408	Chrome plated stainless steel
	Piston Valve	207-472	58-1769	
	Sleeve	178-894	57-1409	Chrome plated stainless steel
	Intake Valve	207-473	58-2006	
	Air Motor Repair Kit	207-730	20-632	10" King air motor
Air Motor Trip Rod	214-852	47-1662	10" King air motor	
55:1 KING	Repair Kit	210-539	20-1268	Polyurethane; model 207-568 pump
	Air Motor Repair Kit	207-730	20-632	10" King air motor
	Air Motor Trip Rod	214-852	47-1662	10" King air motor
63:1 KING	Repair Kit	206-735	20-381	Leather & Teflon
		207-851	20-643	Teflon
		220-399	20-1328	Leather & polyethylene
	Rod	178-899	57-1406	Chrome plated stainless steel
	Piston Valve	205-516	58-1768	
	Sleeve	178-900	57-1407	Chrome plated stainless steel
	Intake Valve	217-476	58-2009	
	Air Motor Repair Kit	207-730	20-632	10" King air motor
Air Motor Trip Rod	214-852	47-1662	10" King air motor	
68:1 KING	Air Motor Repair Kit	207-730	20-632	10" King air motor
	Air Motor Trip Rod	214-852	47-1662	10" King air motor
LINELAZER 3000	Repair Kit	235-703	20-1856	Leather & polyethylene
	Rod	235-709	57-1946	Chrome plated stainless steel
	Piston Valve	218-197	58-1461	
	Cylinder	235-708	57-2099	Stainless steel
	Intake Valve	224-966	58-2215	
	Pressure Transducer	235-009	47-2370	
	Drain Valve Repair Kit	235-014	20-2324	1/4-turn valve
LINELAZER 3500 (non-sleeved pumps)	Repair Kit	222-588	20-1499	Leather & polyethylene
	Piston Rod	222-438	57-1910	Chrome plated stainless steel
	Piston Valve	218-036	58-1775	
	Cylinder	178-949	57-1439	Carbon steel
	Intake Valve	217-574	58-1772	For non-sleeved pumps only
	Pressure Return Hose	223-766	13-1855	1/4"NPS(fbe) x 29"
LINELAZER 3500 (removable sleeved pumps)	Repair Kit	222-588	20-1499	Leather & polyethylene
	Rod	222-438	57-1910	Chrome plated stainless steel
	Piston Valve	218-036	58-1775	
	Sleeve	185-213	57-1911	Stainless steel
	Cylinder, Outlet Housing	185-211	57-2423	Outer casing for sleeve
	Intake Valve	222-437	58-2014	For sleeved pumps only
	Pressure Return Hose	223-766	13-1855	1/4"NPS(fbe) x 29"
	Gun Repair Kit	235-474	20-1930	Silver Gun Plus
LINELAZER 5000	Repair Kit	220-877	20-1500	Leather & polyethylene
	Rod	220-630	57-1776	Chrome plated stainless steel
	Piston Valve	220-631	58-1938	
	Sleeve	183-361	57-1599	Stainless steel
	Cylinder, Outlet Housing	183-181	57-2383	Outer casing for sleeve
	Intake Valve	220-629	58-1944	
	Pressure Return Hose	220-849	13-2151	3/8"NPS(fbe) x 29"
	Gun Repair Kit	235-474	20-1930	Silver Gun Plus
5:1 MONARK	Repair Kit	206-923	20-751	Polyethylene; 205-985, 206-000, 226-206 pumps
		206-926	20-1074	Leather; 205-788, 205-812 pumps
		207-580	20-606	Teflon; 206-393, 206-784, 208-470 pumps
		207-884	20-1178	Teflon; 205-465 pump
		207-917	20-1085	Viton & Teflon; 207-873, 207-874 pumps
		208-519	20-774	Leather; 208-315, 218-956 pumps
		208-520	20-607	Teflon; 218-956 pump
	Air Motor Repair Kit	206-728	20-850	Monark air motor

To order, contact your local
Paint Spray Equipment Dealer and ask for
Genuine Bedford Replacement Parts.

BEDFORD® Replacement Parts For . . . GRACO Equipment

Quick Reference for . . . GRACO Pumps

PUMP MODEL	COMPONENT DESCRIPTIONS	REPLACES GRACO PART NO.	BEDFORD PART NO.	NOTES
14:1 / 15:1 MONARK	Repair Kit	206-733	20-380	Leather & Teflon
	Piston Valve	206-345	58-1584	
	Sleeve	164-481	57-1005	Carbon steel
		178-902	57-1405	Chrome plated stainless steel
	Intake Valve	205-981	58-1583	
	Air Motor Repair Kit	206-728	20-850	Monark air motor
23:1 MONARK	Repair Kit	218-135	20-1084	Leather & Teflon
		218-136	20-1114	Teflon
		223-674	20-1920	Leather & polyethylene, SS
		235-636	20-2310	Leather, Teflon & stainless steel
	Rod	236-724	20-2311	Teflon & stainless steel
		207-084	—	Replaced by 223-603 (57-1402)
	Piston Valve	223-603	57-1402	Chrome plated stainless steel
		205-538	58-1581	Zinc plated carbon steel
	Cylinder, Outlet Housing	223-591	58-2307	Stainless steel
		207-420	57-1965	Carbon steel
Sleeve	178-898	57-1403	Chrome plated stainless steel	
Intake Valve	206-399	58-1582		
	Air Motor Repair Kit	206-728	20-850	Monark air motor
3:1 PRESIDENT	Repair Kit	206-761	20-1626	Leather & Teflon
	Air Motor Repair Kit	207-385	20-845	President air motor
10:1 PRESIDENT	Repair Kit	206-923	20-751	Polyethylene; stainless steel pumps
		206-926	20-1074	Leather; 205-789 pump
		206-927	20-386	Leather; 205-626, 7, 8, 9 pumps
		207-580	20-606	Teflon; stainless steel pumps
		207-949	20-1081	Viton
	Air Motor Repair Kit	207-385	20-845	President air motor
15:1 PRESIDENT	Repair Kit	167-665	2-848	Teflon V-Packing conversion (10 required per pump)
		207-386	20-1351	Leather & Teflon
		220-396	20-1387	Leather & polyethylene
	Air Motor Repair Kit	207-385	20-845	President air motor
28:1 PRESIDENT	Refer to 30:1 PRESIDENT pump repair kits & components, except rods			
30:1 PRESIDENT	Repair Kit	206-733	20-380	Leather & Teflon
		207-850	20-681	Teflon
		223-675	20-1898	Leather & polyethylene
		235-635	20-2079	Leather, Teflon & stainless
	Rod	223-589	57-1404	Chrome plated stainless steel
		206-345	58-1584	Zinc plated carbon steel
	Piston Valve	223-565	58-2306	Stainless steel
		207-420	57-1965	Carbon steel
	Cylinder, Outlet Housing	164-481	57-1005	Carbon steel
		178-902	57-1405	Chrome plated stainless steel
Intake Valve	205-981	58-1583		
	Air Motor Repair Kit	207-385	20-845	President air motor
5:1 SANITARY	Repair Kit	208-497	20-1189	FDA approved rubber
	Air Motor Repair Kit	206-728	20-850	Monark air motor
13:1 SENATOR	Repair Kit	207-966	20-855	Leather & Teflon; Balls ordered separately
		215-496	20-1181	Teflon conversion, Balls ordered separately
		220-395	20-1355	Leather & polyethylene
	Rod	178-888	57-1408	Chrome plated stainless steel
	Piston Valve	207-472	58-1769	
	Sleeve	178-894	57-1409	Chrome plated stainless steel
	Intake Valve	207-473	58-2006	
	Air Motor Repair Kit	218-122	20-1230	Senator air motor
1-1/2:1 STANDARD	Repair Kit	207-848	20-1266	Leather & rubber; 204-456, 207-404 pumps

BEDFORD® Replacement Parts For . . . GRACO Equipment

To order, contact your local
Paint Spray Equipment Dealer and ask for
Genuine Bedford Replacement Parts.

Quick Reference for . . . GRACO Pumps

PUMP MODEL	COMPONENT DESCRIPTIONS	REPLACES GRACO PART NO.	BEDFORD PART NO.	NOTES
2:1 STANDARD	Repair Kit	207-848	20-1266	Leather & rubber; 225-815 pump
		208-178	20-821	Teflon; 208-177 pump
		214-730	20-1174	Teflon; 206-780, 226-040 pumps
	Air Motor Repair Kit	207-848	20-1266	204-464 air motor & fluid section
ULTRA 333 / 433 / 750 / 1000 (non-sleeved pumps)	Repair Kit	222-588	20-1499	Leather & polyethylene
	Rod	222-438	57-1910	Chrome plated stainless steel
	Piston Valve	218-036	58-1775	
	Cylinder	178-949	57-1439	Carbon steel
	Intake Valve	217-574	58-1772	For non-sleeved pumps only
	Pressure Return Hose	223-766	13-1855	1/4"NPS(fbe) x 29"
ULTRA 333 / 433 / 750 / 1000 (removable sleeved pumps)	Repair Kit	222-588	20-1499	Leather & polyethylene
	Rod	222-438	57-1910	Chrome plated stainless steel
	Piston Valve	218-036	58-1775	
	Cylinder, Outlet Housing	185-211	57-2423	Outer casing for sleeve
	Sleeve	185-213	57-1911	Stainless steel
	Intake Valve	222-437	58-2014	For sleeved pumps only
	Pressure Return Hose	223-766	13-1855	1/4"NPS(fbe) x 29"
ULTRA 395	Repair Kit	244-194	20-2428	Leather & polyethylene
	Drain Valve Repair Kit	235-014	20-2324	1/4-turn valve
	Manifold Filter O-Ring	117-828	15-2599	Encapsulated
ULTRA 400 / 500 (non-sleeved pumps)	Repair Kit	222-587	20-1526	Leather & polyethylene
	Rod	181-879	57-1360	Carbon steel
		183-563	57-1748	Chrome plated stainless steel
	Piston Valve	218-197	58-1461	
	Cylinder	177-929	57-1435	Carbon steel
	Intake Valve	215-455	58-1585	For non-sleeved pumps only
	Pressure Return Hose	223-766	13-1855	1/4"NPS(fbe) x 29"
ULTRA 400 / 500 (removable sleeved pumps)	Repair Kit	222-587	20-1526	Leather & polyethylene
	Rod	183-563	57-1748	Chrome plated stainless steel
	Piston Valve	218-197	58-1461	
	Sleeve	183-571	57-1749	Stainless steel
	Intake Valve	221-098	58-2012	For sleeved pumps only
	Pressure Return Hose	223-766	13-1855	1/4"NPS(fbe) x 29"
ULTRA 495	Repair Kit	244-194	20-2428	Leather & polyethylene
	Drain Valve Repair Kit	235-014	20-2324	1/4-turn valve
	Manifold Filter O-Ring	117-828	15-2599	Encapsulated
ULTRA 600	Repair Kit	235-703	20-1856	Leather & polyethylene
	Rod	235-709	57-1946	Chrome plated stainless steel
	Piston Valve	218-197	58-1461	
	Cylinder	235-708	57-2099	Stainless steel
	Intake Valve	224-966	58-2215	
	Drain Valve Repair Kit	235-014	20-2324	1/4-turn valve
ULTRA 1500	Repair Kit	220-877	20-1500	Leather & polyethylene
	Rod	220-630	57-1776	Chrome plated stainless steel
	Piston Valve	220-631	58-1938	
	Cylinder, Outlet Housing	183-181	57-2383	Outer casing for sleeve
	Sleeve	183-361	57-1599	Stainless steel
	Intake Valve	220-629	58-1944	
	Pressure Return Hose	220-849	13-2151	3/8"NPS(fbe) x 29"
ULTRA MAX 695	Repair Kit	244-194	20-2428	Leather & polyethylene
	Piston Valve	243-181	58-2570	
	Intake Valve	243-190	20-2561	23/32", seat, o-ring, ball & spacer
		239-922	20-2673	15/16", seat, ball & o-ring
	Drain Valve Repair Kit	235-014	20-2324	1/4-turn valve
ULTRA MAX II 695 ULTRA MAX 795 ULTRA MAX II 795 ULTRA MAX 1095	Repair Kit	248-212	20-2662	Leather & polyethylene
	Rod	240-518	57-2670	Chrome plated stainless steel
	Piston Valve	239-932	58-2564	
	Sleeve	240-521	57-2273	
	Intake Valve	239-922	20-2673	Includes: ball, seat & o-ring
	Drain Valve Repair Kit	235-014	20-2324	1/4-turn valve

To order, contact your local
Paint Spray Equipment Dealer and ask for
Genuine Bedford Replacement Parts.

BEDFORD® Replacement Parts For . . . GRACO Equipment

Quick Reference for . . . GRACO Pumps

PUMP MODEL	COMPONENT DESCRIPTIONS	REPLACES GRACO PART NO.	BEDFORD PART NO.	NOTES
ULTRA MAX II 1095 ULTRA MAX 1595	Repair Kit	248-213	20-2663	Leather & polyethylene
	Rod	240-517	57-2672	Chrome plated stainless steel
	Piston Valve	240-150	58-2567	
	Sleeve	240-525	57-2529	
	Intake Valve	244-199	20-2713	Includes: ball, seat & o-ring
	Pressure Transducer	235-009	47-2370	
	Drain Valve Repair Kit	235-014	20-2324	1/4-turn valve
VISCOUNT 1000	Repair Kit	206-923	20-751	Teflon & Viton
VISCOUNT II 1000	Rod	223-589	57-1404	Chrome plated stainless steel
	Piston Valve	206-345	58-1584	Zinc plated carbon steel
		223-565	58-2306	Stainless steel
	Cylinder, Outlet Housing	207-420	57-1965	Carbon steel
	Sleeve	164-481	57-1005	Carbon steel
		178-902	57-1405	Chrome plated stainless steel
Intake Valve	205-981	58-1583		
VISCOUNT 3000	Repair Kit	206-733	20-380	Leather & Teflon
		207-850	20-681	Teflon
		223-675	20-1898	Leather & polyethylene
		235-635	20-2079	Leather, Teflon & stainless
	Rod	223-589	57-1404	Chrome plated stainless steel
	Piston Valve	206-345	58-1584	Zinc plated carbon steel
		223-565	58-2306	Stainless steel
	Cylinder, Outlet Housing	207-420	57-1965	Carbon steel
	Sleeve	164-481	57-1005	Carbon steel
		178-902	57-1405	Chrome plated stainless steel
Intake Valve	205-981	58-1583		
VISCOUNT II 4500	Repair Kit	207-966	20-855	Leather & Teflon; Balls ordered separately
		215-496	20-1181	Teflon conversion, Balls ordered separately
		220-395	20-1355	Leather & polyethylene
	Rod	178-888	57-1408	Chrome plated stainless steel
	Piston Valve	207-472	58-1769	
	Sleeve	178-894	57-1409	Chrome plated stainless steel
Intake Valve	207-473	58-2006		

Quick Reference for . . . GRACO Airless Spray Guns

SPRAY GUN	REPAIR KIT		WHERE USED / GUN MODEL NUMBERS
	REPLACES GRACO PART NO.	BEDFORD PART NO.	
CONTRACTOR GUN	218-070	20-1502	217-593, 220-955, 235-990, 243-282, 820-165, 824-950
CONTRACTOR FTx GUN	218-070	20-1502	238-350, 239-045, 239-516, 243-285, 243-374, 243-375, 824-004
CONTRACTOR ST GUN	218-070	20-1502	238-352
CONTRACTOR II GUN	287-031	20-2701	246-220, 246-221, 246-222, 246-224, 246-225, 246-434, 246-538, 824-987
CONTRACTOR FTx-II GUN	287-031	20-2701	246-230 thru 246-235, 246-435, 246-539, 246-540
FLEX GUN	218-143	20-1401	218-132, 220-956
FLEX GUN PLUS	235-474	20-1930	235-457, 235-458, 235-459, 237-691, 243-284 ROAD LAZER SYSTEMS: 231-378, 231-571, 231-572
SG-3 GUN	218-070	20-1502	243-238, 243-382
SILVER GUN	218-143	20-1401	208-327, 208-663, 208-664, 220-954, 222-668 LINELAZER
SILVER GUN PLUS	235-474	20-1930	235-460, 235-461, 235-462, 235-463, 235-464, 236-531, 237-695, 238-591, 238-941, 238-966, 243-283, LINELAZER 3000, LINELAZER 3500, LINELAZER 5000

BEDFORD® Replacement Parts For . . . GRACO Equipment

To order, contact your local
Paint Spray Equipment Dealer and ask for
Genuine Bedford Replacement Parts.

REPLACES GRACO PART NO.	BEDFORD PART NO.	DESCRIPTION	GRACO LIST PRICE (\$)
061-089	13-6	3/8" Red Smooth Air Hose, Reel, 250 PSI	—
061-204	13-4	1/4" Red Smooth Air Hose, Reel, 250 PSI	—
061-207	13-59	5/16" Red Smooth Air Hose, Reel, 250 PSI	—
100-040	12-1483	Plug, 3/8" NPT	3.60
100-063	19-258	Pin	2.95
100-064	9-630	Ball	2.95
100-065	9-657	Ball	2.95
100-069	9-255	Ball	2.95
100-084	9-690	Ball	5.25
100-103	19-391	Cotter Pin	2.95
100-114	9-610	Ball	2.95
100-148	9-691	Ball	2.95
100-279	9-127	Ball	8.35
100-332	9-693	Ball	3.40
100-400	9-669	Ball	4.10
100-403	12-1480	Plug, 1/8" NPT	3.65
100-454	19-1618	Screw	2.95
100-509	12-1481	Plug, 1/4" NPT	3.20
100-721	12-1482	Plug, 1/4" NPT with Hex Socket End	6.95
100-846	12-1309	Grease Fitting	1.15
100-960	28-719	Gauge, 1/4" NPT Btm Mnt, 0-200 PSI, 2"	17.90
101-178	9-128	Ball	22.50
101-180	28-1655	Gauge, 1/4" NPT Btm Mnt, 0-200 PSI, 2"	33.80
101-190	9-617	Ball	10.90
101-201	12-368	1/2" Hose Fitting x 3/8" NPS(f)	—
101-274	19-392	Cotter Pin	2.95
101-391	19-1248	Pin	5.50
101-454	9-1239	Ball	—
101-545	19-393	Cotter Pin	2.95
101-701	9-1554	Ball	12.00
101-718	9-1258	Ball	58.00
101-750	9-883	Ball	12.30
101-822	9-995	Ball	7.30
101-823	9-129	Ball	6.65
101-859	9-996	Ball	7.75
101-874	9-130	Ball	6.25
101-890	19-763	Screw	2.95
101-891	53-1093	Brush, 3/8" Diameter	8.45
101-892	53-1096	Brush, 5/8" Diameter	7.90
101-917	9-153	Ball	13.70
101-946	19-394	Cotter Pin	2.95
101-947	9-244	Ball	3.50
101-956	9-245	Ball	2.95
101-968	9-695	Ball	57.75
102-119	9-1895	Ball	5.05
102-233	9-897	Ball	3.50
102-310	19-1393	Nut	5.35
102-366	19-461	Screw	2.45
102-413	43-1249	Packing	24.40
102-416	43-1250	Packing	36.80
102-417	43-1251	Packing	33.00
102-418	43-1252	Packing	—
102-596	15-818	Teflon O-Ring	15.20
102-642	—	Replaced by 106-260 (15-1695)	—
102-654	17-1236	Impeller	84.25

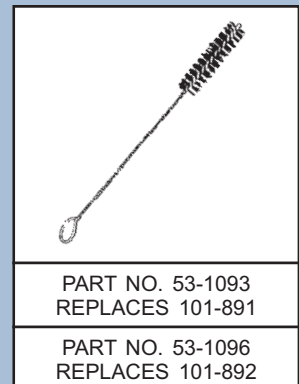
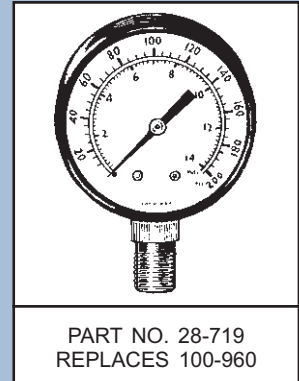

GRACO LIST PRICES ARE BASED ON SINGLE UNIT PRICE IN GRACO U.S. PRICE LIST DATED 12/29/08

To order, contact your local
Paint Spray Equipment Dealer and ask for
Genuine Bedford Replacement Parts.

BEDFORD® Replacement Parts For . . . GRACO Equipment

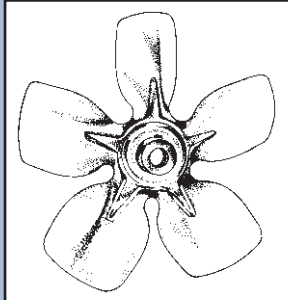

PART NO. 17-1236
REPLACES 102-654

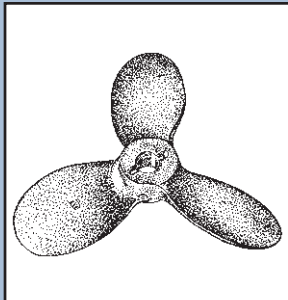

PART NO. 46-1062
REPLACES 159-854

REPLACES GRACO PART NO.	BEDFORD PART NO.	DESCRIPTION	GRACO LIST PRICE (\$)
102-659	11-824	Packing	—
102-727	0-668	O-Ring	51.50
102-861	0-1063	O-Ring	7.75
102-867	0-1053	O-Ring	36.40
102-930	0-1064	O-Ring	20.70
102-952	—	Replaced by 181-073 (14-1224)	—
102-969	22-592	Adhesive	3.70
102-972	9-839	Ball	10.20
102-973	9-692	Ball	24.50
102-974	9-1747	Ball	124.50
103-185	0-1040	O-Ring	8.25
103-186	6-862	Backup Ring	8.45
103-337	0-836	O-Ring	2.70
103-413	0-2741	O-Ring	1.20
103-605	12-301	5/16" Hose Fitting x 1/4" NPS(f)	8.40
103-648	0-877	O-Ring	5.25
103-740	48-972	Switch - EM400	—
104-084	12-306	1/4" Hose Fitting x 3/8" NPS(f)	6.10
104-361	15-432	Teflon O-Ring	12.00
104-412	12-310	Compression Ring for 1/4" Hose Fittings	1.50
104-413	12-312	Compression Ring for 3/8" Hose Fittings	.80
104-414	12-302	3/8" Hose Fitting x 3/8" NPS(f)	5.45
104-415	12-304	1/4" Hose Fitting x 1/4" NPS(f)	5.55
104-445	0-1106	Packing	11.90
104-537	15-2640	Teflon O-Ring	8.25
104-804	15-1434	Teflon O-Ring	5.85
104-892	15-1057	Teflon O-Ring	3.70
104-893	15-1058	Teflon O-Ring	2.85
104-928	—	Replaced by 156-082 (0-597)	—
104-938	0-1847	O-Ring	6.45
104-951	—	Replaced by 170-708 (43-829)	—
105-252	24-1969	Mounting Bracket, Gen'l Purpose Regulator	18.90
105-444	9-140	Ball	2.95
105-445	9-183	Ball	2.70
105-522	43-1253	Seal	12.00
106-093	10-1317	Washer	2.40
106-260	15-1695	Teflon O-Ring	7.80
106-556	0-2333	O-Ring	8.50
107-079	15-2278	Teflon O-Ring	2.40
107-082	0-1238	O-Ring	5.90
107-093	43-1254	Seal	12.90
107-098	15-1543	Teflon O-Ring	4.00
107-109	23-1521	Spring	—
107-110	19-1522	Nut	2.95
107-167	9-2371	Ball	22.00
107-203	9-2380	Ball	8.95
107-245	—	Replaced by 157-785 (12-408)	—
107-306	0-2379	O-Ring	8.50
107-536	9-1975	Ball	5.30
108-266	—	Replaced by 154-771 (0-1383)	—
108-450	19-1261	Cotter Pin	11.80
108-451	49-1353	Polyethylene V-Packing	16.10
108-452	49-1327	Polyethylene V-Packing	16.60
108-453	49-1354	Polyethylene V-Packing	11.20
108-454	49-1380	Polyethylene V-Packing	8.70

GRACO LIST PRICES ARE BASED ON SINGLE UNIT PRICE IN GRACO U.S. PRICE LIST DATED 12/29/08

BEDFORD® Replacement Parts For . . . GRACO Equipment

To order, contact your local
Paint Spray Equipment Dealer and ask for
Genuine Bedford Replacement Parts.

REPLACES GRACO PART NO.	BEDFORD PART NO.	DESCRIPTION	GRACO LIST PRICE (\$)
108-455	49-1912	Polyethylene V-Packing	8.30
108-456	49-1913	Polyethylene V-Packing	8.30
108-526	15-1498	Teflon O-Ring	5.65
108-690	43-1540	Seal, U-Cup	11.00
108-775	9-1541	Ball	7.90
108-822	15-2248	Teflon O-Ring	2.90
108-832	0-2633	O-Ring	4.00
108-954	15-1512	Teflon O-Ring	2.95
108-958	12-1981	Connector, 45°	13.80
108-982	12-1976	Connector, Push-On	5.90
109-303	2-2291	Teflon V-Packing	10.40
109-451	15-1890	Teflon O-Ring	5.55
109-499	15-2644	Teflon O-Ring	7.65
110-110	22-2315	Sealant	17.20
110-165	—	Replaced by 108-526 (15-1498)	—
110-209	24-1972	Mounting Nut, Mini-Regulator	6.25
110-241	0-1788	O-Ring	2.95
110-242	0-1789	O-Ring	2.95
110-321	24-1968	Mounting Bracket & Nut, Mini-Regulator	8.85
110-700	—	Replaced by 100-846 (12-1309)	—
111-317	19-1977	Retaining Clip	2.30
111-599	10-2322	Washer, Flat	1.75
111-603	15-1792	Teflon O-Ring	2.70
111-613	4-2360	Cup Packing	21.70
111-699	8-2316	Gasket	—
111-710	0-2364	O-Ring	3.25
111-711	6-2363	Backup Ring	2.30
112-319	0-2431	O-Ring	11.50
112-561	43-2688	U-Cup Packing	25.60
112-588	—	Replaced by 108-822 (15-2248)	—
112-589	43-2249	U-Cup Seal	9.95
112-591	1-2250	Leather V-Packing	3.55
112-592	49-2251	Polyethylene V-Packing	2.85
112-593	19-2252	Ball Stop Pin	2.10
112-721	9-2312	Ball	—
112-722	9-2313	Ball	—
113-406	—	Order as: Bedford 26-1125 Regulator	—
113-423	0-2689	O-Ring	13.80
114-049	0-2656	O-Ring, Pole Extension	1.50
114-054	0-2284	O-Ring	4.35
117-285	15-2739	Teflon O-Ring	3.85
117-459	0-2597	O-Ring	1.30
117-559	0-2740	O-Ring	2.55
117-828	15-2599	O-Ring, Encapsulated, Outlet Filter	15.20
118-494	0-2657	O-Ring	1.30
118-503	52-2658	Wiper	5.50
118-504	52-2666	Wiper	6.75
118-948	6-2683	Teflon Backup Ring	.90
150-179	3-101	Leather Cup	11.50
150-429	10-1090	Gasket	4.40
150-516	18-636	Male Gland	3.50
150-522	23-625	Spring	3.50
150-540	10-803	Washer	4.70
150-647	10-683	Gasket	3.80
150-670	10-776	Gasket	3.40

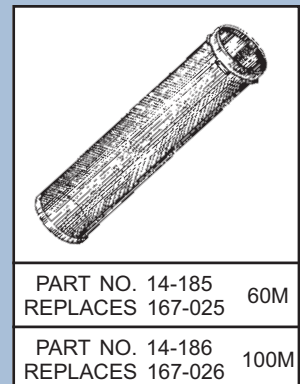
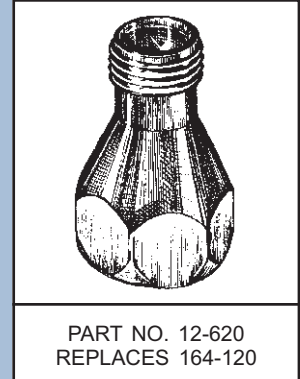

GRACO LIST PRICES ARE BASED ON SINGLE UNIT PRICE IN GRACO U.S. PRICE LIST DATED 12/29/08

To order, contact your local
Paint Spray Equipment Dealer and ask for
Genuine Bedford Replacement Parts.

BEDFORD® Replacement Parts For . . . GRACO Equipment

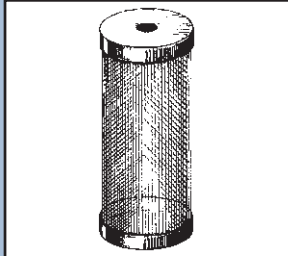

PART NO. 14-193 60M
REPLACES 167-053

PART NO. 14-194 100M
REPLACES 167-054

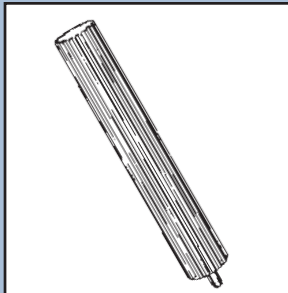

PART NO. 44-1305
REPLACES 171-939

REPLACES GRACO PART NO.	BEDFORD PART NO.	DESCRIPTION	GRACO LIST PRICE (\$)
151-519	12-1978	Nipple, 1/8" NPT x 1/4" NPT	8.90
154-594	0-1246	O-Ring	1.25
154-662	0-144	O-Ring	7.00
154-771	0-1383	O-Ring	6.25
154-986	12-404	Swivel Adapter 3/8" NPT(m) x 1/4" NPS(f)	—
155-470	12-418	Swivel Adapter 1/2" NPT(m) x 1/2" NPS(f) 90°	16.00
155-570	12-409	Swivel Adapter 1/4" NPT(f) x 1/4" NPS(f)	10.30
155-665	12-405	Swivel Adapter 3/8" NPT(m) x 3/8" NPS(f)	7.25
155-685	0-1107	Packing	4.10
155-865	12-412	Swivel Adapter 1/2" NPT(f) x 1/2" NPS(f)	13.40
156-082	0-597	O-Ring	6.15
156-172	12-413	Swivel Adapter 3/4" NPT(f) x 3/4" NPS(f)	26.60
156-173	12-251	Swivel Adapter 3/8" NPT(f) x 3/8" NPS(f)	5.80
156-401	0-2433	O-Ring	7.40
156-454	0-330	O-Ring	3.70
156-589	12-415	Swivel Adapter 3/4" NPT(f) x 3/4" NPS(f) 90°	18.50
156-593	0-957	O-Ring	6.55
156-633	0-139	O-Ring	6.95
156-641	0-102	O-Ring	6.85
156-684	12-465	Swivel Adapter 1/2" NPT(m) x 1/2" NPS(f)	29.60
156-698	0-103	O-Ring	4.70
156-766	10-1424	Gasket	3.45
156-811	3-253	Leather Cup	14.10
156-823	12-402	Swivel Adapter 1/4" NPT(m) x 1/4" NPS(f)	5.90
156-849	12-230	Nipple 3/8" NPT x 3/8" NPT	5.55
156-971	12-228	Nipple 1/4" NPT x 1/4" NPT	2.65
157-127	10-1264	Gasket	4.00
157-250	0-331	O-Ring	9.55
157-277	0-694	O-Ring	13.40
157-350	12-229	Nipple 1/4" NPT x 3/8" NPT	7.70
157-416	12-431	Swivel Adapter 1/2"NPT(f) x 1/2"NPS(f) 90°	12.10
157-628	0-142	O-Ring	2.85
157-630	23-1646	Spring	5.05
157-633	23-1647	Spring	11.50
157-636	18-398	Female Gland	19.10
157-637	1-104	Leather V-Packing	8.50
157-638	18-397	Male Gland	20.40
157-676	12-201	Swivel Adapter 1/4"NPT(f) x 1/4"NPS(f) 90°	25.60
157-705	12-403	Swivel Adapter 1/4" NPT(m) x 3/8" NPS(f)	8.15
157-785	12-408	Swivel Adapter 3/4" NPT(m) x 3/4" NPS(f)	12.00
157-894	18-635	Female Gland	3.20
158-109	5-105	Rubber Gasket	2.95
158-256	12-407	Swivel Adapter 1/2" NPT(m) x 3/8" NPS(f)	16.30
158-367	16-842	Grommet	5.75
158-377	0-131	O-Ring	6.95
158-378	0-132	O-Ring	28.20
158-379	0-135	O-Ring	19.10
158-402	3-149	Leather Cup	15.20
158-486	0-138	O-Ring	3.15
158-491	12-231	Nipple 1/2" NPT x 1/2" NPT	13.30
158-882	3-233	Flange Packing	—
159-239	12-232	Nipple 3/8" NPT x 1/2" NPT	10.20
159-308	11-584	V-Packing	12.00
159-312	18-1041	Male Gland	23.40
159-314	1-150	V-Packing	8.55

GRACO LIST PRICES ARE BASED ON SINGLE UNIT PRICE IN GRACO U.S. PRICE LIST DATED 12/29/08

BEDFORD® Replacement Parts For . . . GRACO Equipment

To order, contact your local
Paint Spray Equipment Dealer and ask for
Genuine Bedford Replacement Parts.

REPLACES GRACO PART NO.	BEDFORD PART NO.	DESCRIPTION	GRACO LIST PRICE (\$)
159-471	17-1263	Spreader	—
159-854	46-1062	Propeller	27.20
15B-112	15-2598	Teflon O-Ring	1.30
15B-958	0-2703	O-Ring	3.55
15C-997	10-2661	Backup Washer	2.10
15C-998	10-2669	Backup Washer	1.95
15E-329	1-2718	Leather V-Packing	4.45
15G-234	52-2743	Wiper, Piston	2.85
160-011	3-243	Leather Packing	—
160-015	0-903	O-Ring	11.50
160-020	3-181	Leather Cup	22.20
160-028	0-422	O-Ring	7.35
160-158	10-686	Gasket	9.50
160-170	5-145	Gasket	—
160-240	7-569	Packing	2.35
160-258	0-1105	Packing	11.20
160-260	—	Order as: (1) pc 170-708 & (1) pc 160-896	—
160-261	44-838	Nut	—
160-325	0-254	O-Ring	12.00
160-430	28-759	Gauge, 1/4" NPT Btm Mount, 0-100 PSI, 2"	22.50
160-618	23-837	Wire	—
160-621	0-133	O-Ring	8.60
160-624	0-616	Packing	13.10
160-625	0-134	O-Ring	13.70
160-634	16-801	Packing	14.70
160-644	16-1605	Flat Packing	11.70
160-671	10-1606	Gasket, Copper	4.00
160-672	18-1607	Guide, Upper	28.40
160-673	16-1608	Packing, Upper	15.00
160-674	6-1609	Washer, Backup	10.30
160-675	18-1610	Guide, Lower	27.00
160-678	18-1611	Guide, Displacement Tube	12.10
160-679	16-1612	Packing	15.00
160-680	6-1613	Guide, Displacement Tube	19.80
160-681	8-1614	Nylon Seal	19.50
160-721	0-1054	O-Ring	11.40
160-896	44-835	Stem	—
161-077	12-411	Swivel Adapter 1/2" NPT(f) x 3/8" NPS(f)	14.10
161-355	—	Replaced by 171-912 (10-859)	—
161-387	0-423	O-Ring	—
161-397	0-421	O-Ring	—
161-416	0-141	O-Ring	—
161-547	0-961	O-Ring	22.00
161-553	10-688	Gasket	4.90
161-559	7-679	Washer	6.60
161-560	16-633	Packing	20.40
161-561	—	Replaced by 214-852 (47-1662)	—
161-562	11-433	V-Packing	24.50
161-563	7-234	Backup Leather	10.50
161-569	10-434	Seal	30.20
161-572	0-1039	O-Ring	5.50
161-575	23-1648	Spring	14.70
161-578	0-462	O-Ring	37.10
161-589	23-1649	Spring	21.20
161-635	10-687	Gasket	9.00

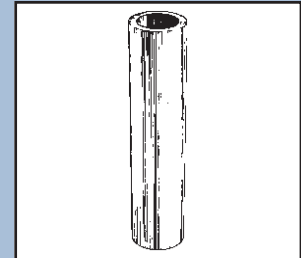

PART NO. 57-1403
REPLACES 178-898

PART NO. 57-1405
REPLACES 178-902



PART NO. 57-1406
REPLACES 178-899

PART NO. 57-1408
REPLACES 178-888

GRACO LIST PRICES ARE BASED ON SINGLE UNIT PRICE IN GRACO U.S. PRICE LIST DATED 12/29/08

To order, contact your local
Paint Spray Equipment Dealer and ask for
Genuine Bedford Replacement Parts.

BEDFORD® Replacement Parts For . . . GRACO Equipment

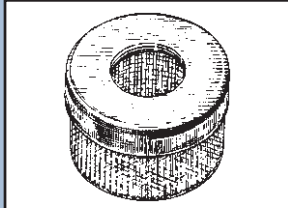

PART NO. 14-1224 REPLACES 181-073	1/2"
PART NO. 14-1428 REPLACES 183-770	3/4"
PART NO. 14-1223 REPLACES 181-072	1"
PART NO. 14-2179 REPLACES 189-920	1"

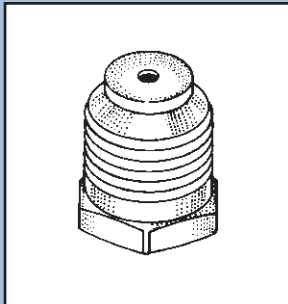

PART NO. 12-1486
REPLACES 181-085

REPLACES GRACO PART NO.	BEDFORD PART NO.	DESCRIPTION	GRACO LIST PRICE (\$)
161-647	—	Replaced by 172-688 (8-977)	—
161-673	10-1267	Gasket	15.40
161-788	4-342	Piston Cup Seal	19.60
161-789	42-819	Bearing	34.60
161-793	4-343	Piston Cup Seal	20.20
161-794	42-820	Bearing	45.80
161-950	8-505	Nylon Packing	31.80
162-302	8-504	Nylon Packing	12.30
162-309	8-510	Nylon Packing	20.50
162-391	1-703	Leather V-Packing	6.30
162-453	12-219	Nipple 1/4" NPT x 1/4" NPS	13.30
162-505	12-406	Swivel Adapter 3/8" NPT(m) x 1/2" NPS(f)	12.80
162-636	3-235	Flange Packing	—
162-642	3-236	Leather Cup	22.20
162-694	1-670	Leather V-Packing	2.55
162-841	0-604	O-Ring	8.05
162-863	8-122	Nylon Tip Gasket 5/32" (Thick)	.80
162-865	4-109	Teflon Cup Packing	27.50
162-866	2-110	Teflon V-Packing	9.90
162-867	4-373	Teflon Flange Packing	44.20
162-868	4-372	Teflon Cup Packing	35.60
162-870	4-993	Packing	61.50
162-871	4-237	Teflon Cup Packing	42.30
162-898	10-981	Gasket	23.80
162-989	5-106	Gasket	2.95
163-010	7-108	Backup Washer	4.70
163-011	11-107	V-Packing	8.55
164-075	8-162	Base, Tip Filter	6.45
164-111	8-241	Gasket	5.35
164-112	23-702	Spring	6.40
164-116	7-120	Packing	2.30
164-120	12-620	Filter Retainer / Adapter, Stainless Steel	30.60
164-396	—	Replaced by 179-983 (18-1082)	—
164-397	1-111	Leather V-Packing	11.30
164-398	—	Replaced by 179-984 (18-1083)	—
164-477	1-115	Leather V-Packing	4.75
164-480	6-378	Teflon Gasket	10.20
164-481	—	Replaced by 178-902 (57-1405)	—
164-555	2-678	Teflon V-Packing	15.40
164-557	15-171	Teflon O-Ring	17.70
164-622	15-424	Teflon O-Ring	28.10
164-623	15-671	Teflon O-Ring	20.80
164-627	16-747	Seal	21.20
164-651	—	Replaced by 178-899 (57-1406)	—
164-652	6-388	Teflon Gasket	12.40
164-654	12-1479	Retainer	33.00
164-655	—	Replaced by 186-132 (18-2159)	—
164-656	1-117	Leather V-Packing	9.00
164-657	—	Replaced by 186-133 (18-1905)	—
164-659	—	Replaced by 178-900 (57-1407)	—
164-713	18-383	Packing Retainer	5.85
164-714	—	Replaced by 179-987 (18-1087)	—
164-715	1-112	Leather V-Packing	3.75
164-716	—	Replaced by 179-988 (18-1088)	—
164-778	42-148	Bearing	—

GRACO LIST PRICES ARE BASED ON SINGLE UNIT PRICE IN GRACO U.S. PRICE LIST DATED 12/29/08

BEDFORD® Replacement Parts For . . . GRACO Equipment

To order, contact your local
Paint Spray Equipment Dealer and ask for
Genuine Bedford Replacement Parts.

REPLACES GRACO PART NO.	BEDFORD PART NO.	DESCRIPTION	GRACO LIST PRICE (\$)
164-782	15-427	Teflon O-Ring	27.60
164-788	42-119	Bearing	—
164-837	18-609	Male Gland	16.30
164-846	15-460	Teflon O-Ring	31.20
164-862	2-116	Teflon V-Packing	10.00
164-891	15-172	Teflon O-Ring	27.00
164-900	8-242	Backup Washer	5.35
164-902	—	Replaced by 172-094 (8-896)	—
164-912	2-113	Teflon V-Packing	14.00
164-913	2-114	Teflon V-Packing	15.30
164-918	2-118	Teflon V-Packing	8.20
164-920	4-390	Teflon Cup Packing	90.75
164-964	15-238	Teflon O-Ring	24.10
165-052	15-239	Teflon O-Ring	19.10
165-098	2-167	Teflon V-Packing	20.00
165-102	2-677	Teflon V-Packing	20.10
165-104	2-165	Teflon V-Packing	17.20
165-109	2-591	Teflon V-Packing	16.50
165-274	12-1394	1/4" NPT(m) Stud	11.70
165-287	6-651	Bearing	16.30
165-288	18-650	Female Gland	33.70
165-289	—	Replaced by 166-133 (11-1750)	—
165-292	6-514	Piston Bearing	13.00
165-295	0-612	O-Ring	11.00
165-592	—	Replaced by 181-085 (12-1486)	—
165-599	12-1395	Stud, 3/8" NPT(m)	25.00
165-651	2-240	Teflon V-Packing	—
165-672	2-420	Teflon V-Packing	8.30
165-894	18-256	Male Gland	7.40
165-895	18-257	Female Gland	6.65
165-944	18-978	Male Gland	—
165-945	18-979	Female Gland	—
165-964	12-1396	Nut	24.40
166-026	6-511	Piston Seal	30.70
166-073	15-469	Teflon O-Ring	20.90
166-075	2-437	Teflon V-Packing	21.00
166-080	0-143	O-Ring	4.10
166-119	0-984	O-Ring	4.05
166-130	5-963	Gasket	1.90
166-133	11-1750	Packing	6.60
166-165	2-147	Teflon V-Packing	14.80
166-226	2-180	Teflon V-Packing	22.00
166-228	18-991	Male Gland	13.10
166-229	18-980	Female Gland	26.80
166-238	0-841	O-Ring	5.85
166-258	7-1382	Packing	3.70
166-374	—	Replaced by 168-283 (6-613)	—
166-375	18-512	Female Gland	102.50
166-378	0-717	O-Ring	6.95
166-395	8-515	Nylon Packing	14.00

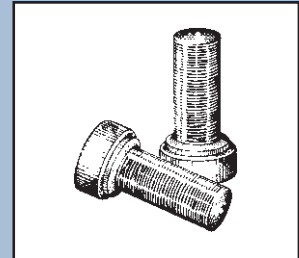

PART NO. 14-151 100M
REPLACES 205-264

PART NO. 14-152 60M
REPLACES 205-265

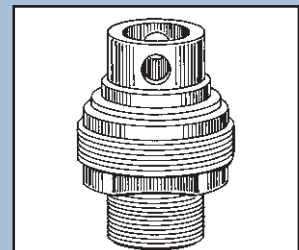

PART NO. 58-1583
REPLACES 205-981

PART NO. 58-1582
REPLACES 206-399

GRACO LIST PRICES ARE BASED ON SINGLE UNIT PRICE IN GRACO U.S. PRICE LIST DATED 12/29/08

To order, contact your local
Paint Spray Equipment Dealer and ask for
Genuine Bedford Replacement Parts.

BEDFORD® Replacement Parts For . . . GRACO Equipment

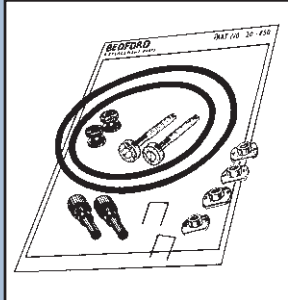

PART NO. 20-850
REPLACES 206-728

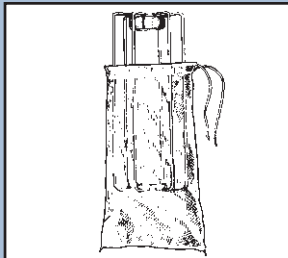

PART NO. 14-700
REPLACES 208-241 3/4"

PART NO. 14-900
REPLACES 210-726 1-1/4"

REPLACES GRACO PART NO.	BEDFORD PART NO.	DESCRIPTION	GRACO LIST PRICE (\$)
166-411	15-395	Teflon O-Ring	51.75
166-412	15-396	Teflon O-Ring	20.80
166-487	18-1619	Male Gland	50.00
166-488	18-1620	Female Gland	74.25
166-489	1-341	Leather V-Packing	13.60
166-490	1-1113	Packing	13.70
166-512	6-608	Washer	6.95
166-564	6-1100	Bearing	8.95
166-602	3-1076	Leather Cup	44.00
166-603	1-1077	Leather V-Packing	27.60
166-612	15-507	Teflon O-Ring	13.10
166-623	15-463	Teflon O-Ring	9.30
166-624	15-466	Teflon O-Ring	19.10
166-650	10-804	Gasket	—
166-651	10-805	Gasket	—
166-652	10-1621	Gasket	11.70
166-653	10-1622	Gasket	11.20
166-702	0-2244	O-Ring	3.35
166-769	2-994	Teflon V-Packing	8.25
166-770	2-849	Teflon V-Packing	25.40
166-811	6-414	Valve Seat	12.70
166-815	18-822	Male Gland	13.80
166-816	2-435	Teflon V-Packing	7.40
166-817	18-823	Female Gland	21.70
166-969	8-173	Nylon Tip Washer 1/16" (Thin)	.65
166-985	15-1103	Teflon O-Ring	18.20
166-987	4-1160	Packing	—
167-024	14-184	Strainer, Manifold Filter - 30 Mesh (Long)	8.70
167-025	14-185	Strainer, Manifold Filter - 60 Mesh (Long)	8.70
167-026	14-186	Strainer, Manifold Filter - 100 Mesh (Long)	8.70
167-027	14-187	Strainer, Manifold Filter - 200 Mesh (Long)	8.70
167-052	14-192	Strainer, Manifold Filter - 30 Mesh (Short)	8.70
167-053	14-193	Strainer, Manifold Filter - 60 Mesh (Short)	8.70
167-054	14-194	Strainer, Manifold Filter - 100 Mesh (Short)	8.70
167-055	14-195	Strainer, Manifold Filter - 200 Mesh (Short)	8.70
167-077	—	Replaced by 178-898 (57-1403)	—
167-354	18-997	Male Gland	58.25
167-355	18-998	Male Gland	76.00
167-585	23-1650	Spring	11.30
167-664	18-1365	Female Gland	25.10
167-665	2-848	Teflon V-Packing	13.40
167-666	1-1326	Leather V-Packing	9.55
167-667	18-1366	Male Gland	17.10
167-668	6-1350	Gasket	10.80
167-730	10-684	Gasket	3.05
167-893	—	Replaced by 178-894 (57-1409)	—
167-894	6-854	Gasket	4.70
167-896	—	Replaced by 186-130 (18-1656)	—
167-897	1-464	Leather V-Packing	8.20
167-898	2-468	Teflon V-Packing	9.85

GRACO LIST PRICES ARE BASED ON SINGLE UNIT PRICE IN GRACO U.S. PRICE LIST DATED 12/29/08

BEDFORD® Replacement Parts For . . . GRACO Equipment

To order, contact your local
Paint Spray Equipment Dealer and ask for
Genuine Bedford Replacement Parts.

REPLACES GRACO PART NO.	BEDFORD PART NO.	DESCRIPTION	GRACO LIST PRICE (\$)
167-899	—	Replaced by 186-131 (18-1902)	—
167-901	—	Replaced by 178-888 (57-1408)	—
167-969	8-1078	Bearing	95.75
167-971	16-1184	Piston Seal	42.10
167-972	0-985	O-Ring	1.35
168-110	0-1104	O-Ring	1.95
168-183	10-689	Gasket	7.00
168-283	6-613	Bearing	29.20
168-285	6-614	Bearing	20.80
168-506	16-1072	Packing	45.10
168-517	12-1201	Housing	29.80
168-521	10-1455	Copper Washer	—
168-548	2-216	Teflon V-Packing	—
168-851	18-1615	Male Gland	11.80
168-852	18-1616	Bearing	39.00
169-133	18-1042	Female Gland	36.90
169-428	1-369	Leather V-Packing	—
169-429	2-340	Teflon V-Packing	—
169-605	18-538	Female Gland	11.30
169-606	18-537	Male Gland	11.70
169-607	1-590	Leather V-Packing	5.35
169-608	2-426	Teflon V-Packing	10.60
169-967	12-1332	Quick Disconnect Plug 1/4" NPT(f)	1.10
169-970	12-1333	Quick Disconnect Plug 1/4" NPT(m)	.95
169-971	12-1334	Quick Disconnect Plug 3/8" NPT(m)	1.40
170-101	10-1265	Gasket	8.15
170-110	10-596	Washer	3.70
170-240	—	Use 4' x 3/4" Fluid Hose (13-1190)	—
170-607	—	Replaced by 206-345 (58-1584)	—
170-608	—	Replaced by 206-345 (58-1584)	—
170-625	49-737	Packing	13.80
170-626	49-802	Packing	53.00
170-706	13-2557	4' x 1" ID Suction Hose (Cut Length)	46.20
170-708	43-829	Poppet	9.35
170-709	43-828	Poppet	9.05
170-959	—	Replaced by 181-072 (14-1223)	—
171-146	18-667	Male Gland	6.35
171-163	18-1623	Gasket	14.10
171-590	17-861	Spreader	22.00
171-591	17-1624	Spreader	26.80
171-593	10-866	Washer	—
171-594	10-825	Washer	4.15
171-912	10-859	Gasket	2.95
171-913	10-860	Gasket	2.95
171-939	44-1305	Filter Support (Aluminum), Outlet Manifold	22.10
171-941	23-1563	Spring, Manifold Outlet Filter	6.25
171-942	12-1564	Head, Manifold Outlet Filter	98.75
172-094	8-896	Seat	9.90
172-383	—	Replaced by 178-543 (18-1467)	—
172-384	1-583	Leather V-Packing	7.60

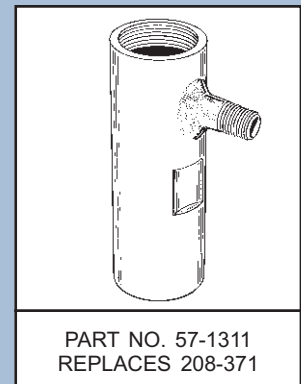
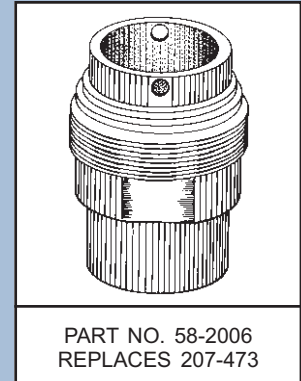

GRACO LIST PRICES ARE BASED ON SINGLE UNIT PRICE IN GRACO U.S. PRICE LIST DATED 12/29/08

To order, contact your local
Paint Spray Equipment Dealer and ask for
Genuine Bedford Replacement Parts.

BEDFORD® Replacement Parts For . . . GRACO Equipment

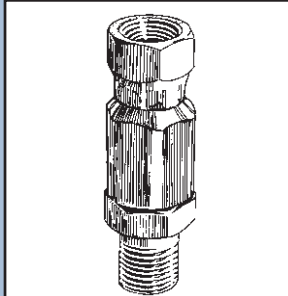

PART NO. 14-1200
REPLACES 210-500

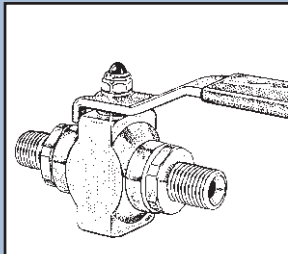

PART NO. 29-1440
REPLACES 210-657 1/4"

PART NO. 29-1441
REPLACES 210-658 3/8"

REPLACES GRACO PART NO.	BEDFORD PART NO.	DESCRIPTION	GRACO LIST PRICE (\$)
172-385	18-1463	Male Gland	15.90
172-392	3-578	Leather Cup	7.50
172-423	18-857	Male Gland	10.30
172-424	18-858	Female Gland	11.80
172-487	2-577	Teflon V-Packing	8.20
172-489	4-1464	Teflon Cup	17.50
172-580	17-203	Spreader	19.60
172-688	8-977	Washer	36.60
172-831	44-1565	Bowl, Manifold Outlet Filter	99.00
172-846	1-940	Leather V-Packing	7.25
172-871	2-919	Teflon V-Packing	22.40
176-167	49-1115	Gasket	2.55
176-648	—	Replaced by 181-084 (12-1587)	—
176-747	18-1282	Female Gland	6.70
176-749	1-1240	Leather V-Packing	3.15
176-750	18-1283	Male Gland	2.95
176-751	19-2628	Lower Packing Nut - Ultra 400, 390st, 490st	9.80
176-754	18-1284	Male Gland	5.30
176-755	1-1241	Leather V-Packing	4.70
176-756	—	Replaced by 176-997 (49-1276)	—
176-757	18-1285	Female Gland	3.15
176-759	19-1286	Pin	13.40
176-761	10-1287	Gasket	3.50
176-818	44-2654	Attach Pin	6.10
176-882	49-1275	V-Packing	6.60
176-884	8-1288	Backup Washer	2.95
176-920	—	Replaced by 188-150 (13-499)	—
176-997	49-1276	V-Packing	6.85
177-159	49-1465	Cup Packing	17.70
177-164	49-1466	Packing	7.05
177-222	49-1523	Needle Packing	—
177-223	18-1524	Gland	—
177-929	57-1435	Cylinder - EM390, EM490, Ultra 400/500	262.50
178-543	18-1467	Female Gland	41.20
178-743	12-1397	Valve Housing	33.40
178-745	12-1398	Valve Stem	25.40
178-746	9-1257	Valve Ball	22.90
178-747	20-1446	Heavy Duty Lever Kit - Ball Valve	8.75
178-888	57-1408	Rod - 45:1 King, GH733, 20:1 Bulldog (SD)	689.00
178-894	57-1409	Sleeve - 45:1 King, GH733, 20:1 Bulldog (SD)	729.00
178-898	57-1403	Sleeve - 23:1 Monark, EH333 (SD)	403.00
178-899	57-1406	Rod - 30:1 Bulldog, GH533, 63:1 King (SD)	667.00
178-900	57-1407	Sleeve - 30:1 Bull, GH533, 63:1 King (SD)	725.00
178-902	57-1405	Sleeve - 30:1 Pres, EH433GT, GH433 (SD)	508.00
178-938	19-1289	Pin	7.20
178-939	1-1242	Leather V-Packing	—
178-940	1-1243	Leather V-Packing	6.40
178-942	18-1294	Male Gland	7.20
178-943	18-1295	Female Gland	10.80
178-944	18-1296	Male Gland	6.95

GRACO LIST PRICES ARE BASED ON SINGLE UNIT PRICE IN GRACO U.S. PRICE LIST DATED 12/29/08

BEDFORD® Replacement Parts For . . . GRACO Equipment

To order, contact your local
Paint Spray Equipment Dealer and ask for
Genuine Bedford Replacement Parts.

REPLACES GRACO PART NO.	BEDFORD PART NO.	DESCRIPTION	GRACO LIST PRICE (\$)
178-945	19-2629	Lower Packing Nut - GM3500, Ultra 1000	11.80
178-949	57-1439	Cylinder - Ultra 333/433/750/1000, GM3500	277.00
178-964	49-1297	V-Packing	4.80
178-965	49-1298	V-Packing	5.95
178-969	18-1299	Female Gland	10.20
179-722	8-1476	Retainer	2.70
179-731	14-1118	Gun Filter Element - 50 Mesh, Coarse	3.40
179-732	14-1120	Gun Filter Element - 100 Mesh, Fine	3.35
179-750	8-1475	Retainer	2.95
179-762	10-1525	Washer, Backup	—
179-763	23-1478	Spring	2.95
179-810	17-2422	Plug	2.70
179-957	8-1477	Retainer	2.70
179-983	18-1082	Gland	3.95
179-984	18-1083	Male Gland	3.20
179-987	18-1087	Gland	2.50
179-988	18-1088	Gland	2.65
180-073	18-1290	Female Gland	7.20
180-161	—	Replaced by 186-652 (18-1846)	—
180-656	17-2424	Plug	2.55
181-072	14-1223	Inlet Strainer - 1" NPT (Stainless Steel Cap)	14.60
181-073	14-1224	Inlet Strainer - 1/2" NPT (Stainless Steel Cap)	16.80
181-084	12-1587	Gun Adapter - Binks Gun to RAC Tip	12.70
181-085	12-1486	Gun Adapter - RAC, Pole Gun, Wagner Gun	7.85
181-338	18-1301	Backup Washer	2.70
181-072P	14-2353	Inlet Strainer - 1" NPT (Nylon Cap)	—
181-073P	14-2351	Inlet Strainer - 1/2" NPT (Nylon Cap)	—
181-879	57-1360	Rod - Ultra 400/500, EM380/390/490	127.00
183-171	17-1542	Plug	2.70
183-172	6-1539	Teflon Packing	16.30
183-173	19-1544	Pin, Ball Stop	5.40
183-174	1-1545	Leather V-Packing	5.20
183-175	1-1546	Leather V-Packing	5.20
183-176	18-1547	Male Gland	9.65
183-177	18-1548	Female Gland	12.70
183-178	18-1549	Male Gland	12.70
183-181	57-2383	Cylinder - GM5000, GM10000, Ultra 1500	239.00
183-182	49-1550	V-Packing	2.95
183-183	49-1551	V-Packing	3.40
183-184	—	Replaced by 186-653 (18-1904)	—
183-185	18-1553	Female Gland	13.80
183-239	—	Replaced by 183-563 (57-1748)	—
183-361	57-1599	Sleeve - GM5000, Ultra 1500, GM 10000	277.00
183-548	58-1979	Seat - Thumb Screw Dump Valve	15.30
183-555	19-1516	Pin	14.80
183-563	57-1748	Rod - Ultra 400/500, EM380/390/490	209.00
183-571	57-1749	Sleeve - Ultra 400/500, EM380/390/490	141.00
183-640	18-1371	Male Gland	18.40
183-641	18-1372	Female Gland	21.20
183-642	18-1373	Male Gland	20.70

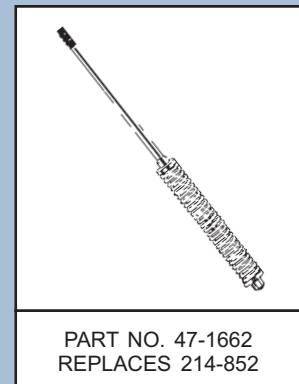
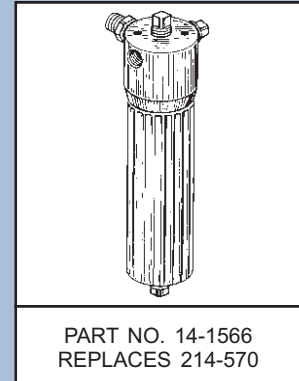

GRACO LIST PRICES ARE BASED ON SINGLE UNIT PRICE IN GRACO U.S. PRICE LIST DATED 12/29/08

To order, contact your local
Paint Spray Equipment Dealer and ask for
Genuine Bedford Replacement Parts.

BEDFORD® Replacement Parts For . . . GRACO Equipment

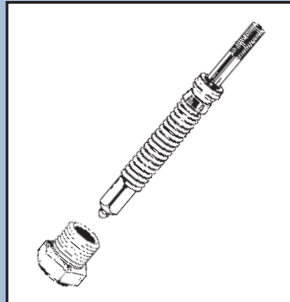

PART NO. 20-1502
REPLACES 218-070

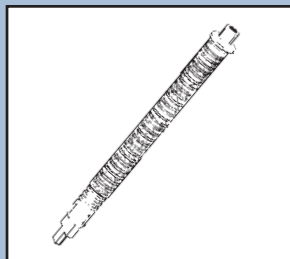

PART NO. 14-1484 50M
REPLACES 218-131

PART NO. 14-1485 100M
REPLACES 218-133

REPLACES GRACO PART NO.	BEDFORD PART NO.	DESCRIPTION	GRACO LIST PRICE (\$)
183-643	18-1374	Female Gland	20.70
183-644	18-1375	Male Gland	21.90
183-645	18-1376	Female Gland	15.40
183-770	14-1428	Inlet Strainer - 3/4" NPT (Stainless Steel Cap)	16.80
183-978	2-1899	Teflon V-Packing	10.40
183-770P	14-2352	Inlet Strainer - 3/4" NPT (Nylon Cap)	—
184-198	18-2292	Female Gland	9.60
184-248	18-2293	Male Gland	9.60
184-303	1-2290	Leather V-Packing	12.90
185-211	57-2423	Cylinder - GM3500, Ultra 1000	207.50
185-213	57-1911	Sleeve - Ultra 750/1000, GM3500	181.00
185-385	10-1903	Shim	2.55
186-130	18-1656	Male Gland	17.90
186-131	18-1902	Female Gland	18.90
186-132	18-2159	Male Gland	13.20
186-133	18-1905	Female Gland	13.20
186-181	18-1896	Female Gland	8.95
186-182	18-1897	Male Gland	8.95
186-194	18-1914	Female Gland	5.85
186-196	18-1916	Male Gland	12.20
186-198	18-1917	Female Gland	5.85
186-199	18-1918	Backup Washer	8.45
186-652	18-1846	Backup Washer	3.85
186-653	18-1904	Backup Washer	8.35
187-060	8-1980	Gasket	1.95
187-147	—	Replaced by 181-072 (14-1223)	—
187-190	—	Replaced by 183-770 (14-1428)	—
187-613	57-1948	Rod - 390st	90.50
187-615	58-2317	Seat	—
187-621	12-2318	Housing, Drain Valve	—
187-623	23-2320	Spring	—
187-634	—	Replaced by 236-786 (57-2131)	—
188-150	13-499	Suction Hose, 3/4" x 3' (No Fittings)	23.70
189-584	18-2253	Female Gland	7.95
189-585	18-2254	Male Gland	13.20
189-587	10-2255	Backup Washer	16.70
189-588	18-2256	Female Gland	14.00
189-590	6-2257	Gasket	4.75
189-920	14-2179	Inlet Strainer - 1" NPT, 8 Mesh, Single Screen	19.10
190-180	17-1437	Lever, Ball Valve	27.50
192-642	20-2717	Intake Valve Kit - Seat (15/16"), Ball & O-Ring	71.25
192-692	49-2285	Polyethylene V-Packing	5.15
192-693	49-2286	Polyethylene V-Packing	4.20
192-710	49-2279	Polyethylene V-Packing	5.15
192-712	49-2280	Polyethylene V-Packing	4.20
192-714	23-2287	Throat Spacer	4.65
192-729	—	Replaced by 195-368 (23-2402)	—
192-848	18-2288	Male Gland	—
193-069	18-2282	Male Gland	3.15
193-124	49-2335	Polyethylene V-Packing	3.15

GRACO LIST PRICES ARE BASED ON SINGLE UNIT PRICE IN GRACO U.S. PRICE LIST DATED 12/29/08

BEDFORD® Replacement Parts For . . . GRACO Equipment

To order, contact your local
Paint Spray Equipment Dealer and ask for
Genuine Bedford Replacement Parts.

REPLACES GRACO PART NO.	BEDFORD PART NO.	DESCRIPTION	GRACO LIST PRICE (\$)
193-125	49-2336	Polyethylene V-Packing	2.75
193-127	23-2337	Throat Spacer	3.55
193-397	23-2376	Spacer	5.00
193-722	49-2377	Polyethylene V-Packing	2.10
194-117	44-2373	Pin	28.70
194-175	18-2372	Female Gland	8.00
195-083	—	Replaced by 243-070	—
195-129	18-2398	Male Gland	4.10
195-134	10-2549	Spacer	1.80
195-136	15-2401	Teflon O-Ring	1.50
195-368	23-2402	Spacer	—
195-488	8-2378	Piston Guide	20.70
195-523	44-2374	Pin	17.30
196-757	—	Replaced by (1) each: 118-504 & 15C-997	—
196-758	—	Replaced by (1) each: 118-503 & 15C-997	—
196-759	—	Replaced by 15G-234 (52-2743)	—
196-866	58-2712	Intake Seat (1-1/4") - UMax1595, GMax5900	78.00
196-880	18-2426	Male Gland	2.45
197-443	44-2634	Pin	7.65
198-303	42-2574	Guide	18.30
198-701	49-2635	Polyethylene V-Packing	3.55
198-718	1-2636	Leather V-Packing	8.80
198-765	18-2637	Female Gland	11.30
198-768	18-2638	Male Gland	11.30
198-967	18-2573	Male Gland	—
204-164	20-1617	Kit - 45:1 Fireball	228.50
204-940	—	Replaced by 239-663 (12-2400)	—
205-139	—	Replaced by 210-867 (13-354)	—
205-142	13-481	25' x 3/8" Fluid Hose Assembly	79.00
205-143	13-482	50' x 3/8" Fluid Hose Assembly	—
205-160	13-485	15' x 3/8" Fluid Hose Assembly	67.25
205-264	14-151	Tip Filter, 100 Mesh, Fine, Enamel & Stain	7.20
205-265	14-152	Tip Filter, 60 Mesh, Coarse, Latex	7.20
205-516	58-1768	Piston Valve - 30:1 Bull, GH533, 63:1 King	226.50
205-538	58-1581	Piston Valve - EH333, 23:1 Monark	87.25
205-981	58-1583	Intake Valve - EH433GT, GH433, 30:1 Pres	360.00
205-982	—	Available Only as 205-981 Intake Valve	—
206-199	—	Order as (1) each: 26-714 & 28-719	—
206-345	58-1584	Piston Valve - EH433GT, GH433, 30:1 Pres	53.50
206-399	58-1582	Intake Valve - EH333, 23:1 Monark	407.00
206-728	20-850	Kit - Fireball & Monark Air Motor	81.25
206-729	—	Replaced by 218-135 (20-1084)	—
206-733	20-380	Kit - 30:1 President, Viscount 3000	102.50
206-734	20-631	Kit - Bulldog Air Motor (7")	95.75
206-735	20-381	Kit - 30:1 Bulldog, GH533, 63:1 King	161.50
206-761	20-1626	Kit - 3:1 President	221.50
206-922	20-1050	Kit - 2:1 Monark	187.50
206-923	20-751	Kit - 5:1 Monark, 10:1 Pres, Viscount 1000	118.50
206-924	20-1047	Kit - 5:1 Fireball	171.00
206-926	20-1074	Kit - 5:1 Monark, 10:1 President	217.00

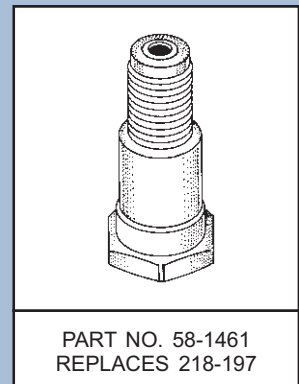
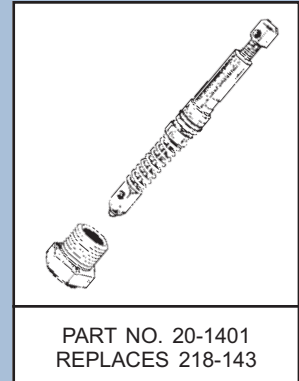

GRACO LIST PRICES ARE BASED ON SINGLE UNIT PRICE IN GRACO U.S. PRICE LIST DATED 12/29/08

To order, contact your local
Paint Spray Equipment Dealer and ask for
Genuine Bedford Replacement Parts.

BEDFORD® Replacement Parts For . . . GRACO Equipment

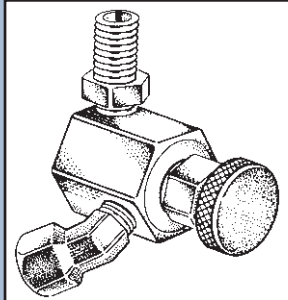

PART NO. 29-1974
REPLACES 222-198



PART NO. 12-1900
REPLACES 223-341

PART NO. 12-2400
REPLACES 239-663

REPLACES GRACO PART NO.	BEDFORD PART NO.	DESCRIPTION	GRACO LIST PRICE (\$)
206-927	20-386	Kit - 9:1 & 10:1 President	171.00
206-933	20-315	Kit - 10:1 Bulldog Double Ball	—
206-934	20-806	Kit - 10:1 Bulldog HydraClean	253.00
206-935	—	Order as: (3) pc 207-839 (20-634)	—
206-939	20-384	Kit - Reverse-A-Clean (RAC)	—
207-011	—	Use: 207-420 (Bedford 57-1965)	—
207-084	—	Replaced by 223-603 (57-1402)	—
207-182	20-385	Kit - 1:1 Pump	53.00
207-240	14-370	Filter Bags - 12 Pack	54.00
207-241	14-700	Filter Assembly - For 3/4" Tube	45.50
207-308	20-990	Kit - HydraClean Valve	56.00
207-385	20-845	Kit - President Air Motor	74.75
207-386	20-1351	Kit - 15:1 President	122.50
207-472	58-1769	Piston Valve - 45:1 King, GH733, 20:1 Bull	216.00
207-473	58-2006	Intake Valve - 45:1 King, GH733, 20:1 Bull	476.00
207-580	20-606	Kit - 5:1 Monark, 10:1 President	164.00
207-581	20-999	Kit - 10:1 Bulldog (SS, Teflon)	311.00
207-729	20-983	Kit - 20:1 King, 10:1 Bulldog, GH833	270.00
207-730	20-632	Kit - King Air Motor (10")	95.50
207-839	20-634	Kit - High Pressure Swivel (Leather)	20.50
207-846	20-387	Kit - 1:1 Solvent Fast-Flo	81.25
207-847	20-371	Kit - 1:1 Fast-Flo SS	—
207-849	—	Replaced by 218-136 (20-1114)	—
207-850	20-681	Kit - 28:1 & 30:1 President (Teflon)	103.50
207-851	20-643	Kit - 30:1 Bull, GH533, 63:1 King (Teflon)	155.00
207-884	20-1178	Kit - 5:1 Monark (Teflon)	136.50
207-917	20-1085	Kit - 5:1 Monark	121.50
207-949	20-1081	Kit - 10:1 President (Viton, SS)	136.50
207-966	20-855	Kit - 20:1 Bulldog, 45:1 King, GH733	144.50
208-178	20-821	Kit - 2:1 Standard Pump	133.50
208-238	20-840	Kit - SST Spray Guns	60.75
208-519	20-774	Kit - 5:1 Monark	133.50
208-520	20-607	Kit - 5:1 Monark Divorced	158.00
208-536	12-1330	Quick Disconnect Coupler 1/4" NPT(f)	7.75
208-919	20-389	Kit - EH433GT	84.25
208-940	20-379	Kit - EM400, EM480	84.25
210-037	—	Order as: (1) pc 208-574 & (1) pc 208-567	—
210-041	—	Replaced by 223-589 (57-1404)	—
210-500	14-1200	Inline Filter Assy, 1/4" NPT(m) x 1/4" NPS(f)	67.25
210-501	12-1202	Housing	58.75
210-539	20-1268	Kit - 55:1 King, 20:1 Bulldog	159.50
210-540	—	Replaced by 223-540 (13-931)	—
210-541	—	Replaced by 223-541 (13-932)	—
210-657	29-1440	1/4" NPT x 1/4" NPT 5000 PSI Ball Valve	66.75
210-658	29-1441	3/8" NPT x 3/8" NPT 5000 PSI Ball Valve	66.75
210-659	29-1442	3/8" NPT x 1/4" NPT 5000 PSI Ball Valve	66.75
210-726	14-900	Filter Assembly - For 1-1/4" Tube	40.20
210-826	—	Replaced by 217-559 (20-1259)	—
210-866	13-366	15' x 5/16" Air Hose Assembly (Smooth)	39.10
210-867	13-354	25' x 5/16" Air Hose Assembly (Smooth)	56.75

GRACO LIST PRICES ARE BASED ON SINGLE UNIT PRICE IN GRACO U.S. PRICE LIST DATED 12/29/08

BEDFORD® Replacement Parts For . . . GRACO Equipment

To order, contact your local
Paint Spray Equipment Dealer and ask for
Genuine Bedford Replacement Parts.

REPLACES GRACO PART NO.	BEDFORD PART NO.	DESCRIPTION	GRACO LIST PRICE (\$)
210-868	13-355	50' x 5/16" Air Hose Assembly (Smooth)	102.00
212-058	—	Order (1) ea: 164-120, 205-264/5, 162-863	—
212-079	20-1269	Kit - 40:1 Bulldog, Polyurethane	217.50
213-012	20-1468	Kit - 1:1 Metric Fast-Flo (Leather)	94.00
213-013	20-1469	Kit - 1:1 Metric Fast-Flo (Teflon)	93.75
214-037	29-1443	1/4" NPT(mbe) Teflon 5000 PSI Ball Valve	66.75
214-570	14-1566	3000 PSI Fluid Outlet Filter Assembly	174.50
214-638	—	Replaced by 223-763 (13-314)	—
214-697	13-797	50' x 3/16" Airless Hose Assembly	71.00
214-698	13-796	25' x 3/16" Airless Hose Assembly	45.30
214-699	13-793	6' x 3/16" Airless Hose Assembly	37.30
214-700	13-791	2' x 3/16" Airless Hose Assembly	—
214-701	13-792	3' x 3/16" Airless Hose Assembly	—
214-703	13-451	25' x 3/8" Airless Hose Assembly	—
214-705	13-453	50' x 3/8" Airless Hose Assembly	—
214-730	20-1174	Kit - 2:1 Standard Pump	—
214-852	47-1662	Trip Rod Assy - Bulldog & King Air Motor	168.00
214-960	13-491	3-1/2" x 3/4" Suction Hose Assembly	69.25
214-961	13-492	6' x 3/4" Suction Hose Assembly	77.00
214-967	58-1430	Diffuser Seat Assembly - Silver/Flex Gun	—
214-981	13-795	15' x 3/16" Airless Hose Assembly	38.90
215-455	58-1585	Intake Valve - Ultra 400, EM380/390/490	207.00
215-496	20-1181	Kit - 45:1 King, GH733, 20:1 Bull (Teflon)	—
215-964	20-1470	Kit - 1:1 Metric Fast-Flo (Polyethylene)	85.50
216-126	13-1303	Outlet Return Hose Assy, 23" - EM480	—
217-474	—	Replaced by 207-851 (20-643)	—
217-475	—	Replaced by 206-735 (20-381)	—
217-476	58-2009	Intake Valve - 30:1 Bull, GH533, 63:1 King	493.00
217-541	—	Replaced by 223-589 (57-1404)	—
217-559	20-1259	Kit - Ball Valve, Viton Packed	61.75
217-560	20-1260	Kit - Ball Valve, Teflon Packed	61.75
217-574	58-1772	Intake Valve - Ultra 333/433/750/1000	235.00
218-017	—	Replaced by 222-438 (57-1910)	—
218-021	47-2062	Gun Swivel - Contractor Gun	65.00
218-023	58-1506	Diffuser Assembly - Contractor Gun	—
218-024	—	Replaced by Graco 238-169 (47-2261)	—
218-036	58-1775	Piston Valve - Ultra 333/433/1000, GM3500	92.00
218-070	20-1502	Kit - Contractor Gun	85.25
218-083	—	Replaced by 223-766 (13-1855)	—
218-122	20-1230	Kit - Senator Air Motor	83.50
218-129	58-1400	Needle Assembly - Silver/Flex Gun	—
218-131	14-1484	Gun Filter Assembly - 50 Mesh, Coarse	7.20
218-133	14-1485	Gun Filter Assembly - 100 Mesh, Fine	7.20
218-135	20-1084	Kit - 23:1 Monark, EH333, EH300	93.75
218-136	20-1114	Kit - 23:1 Monark, EH333 (Teflon)	81.00
218-143	20-1401	Kit - Silver Gun, Flex Gun	89.75
218-197	58-1461	Piston Valve - Ultra 400/600, EM380/390/490	57.00
218-559	20-1385	Kit - 15:1 President (Teflon)	58.75
218-578	—	Replaced by 218-083 (13-1304)	—
218-600	—	Order: (5) pcs 166-969 (8-173)	—



PART NO. 57-1402
REPLACES 223-603

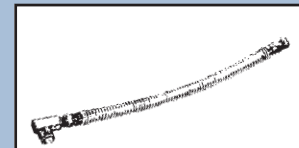

PART NO. 13-314 1/4"x15"
REPLACES 223-763 90°

PART NO. 13-1303 1/4"x23"
REPLACES 216-126 90°

PART NO. 13-1855 1/4" x
REPLACES 223-766 29"

PART NO. 13-2151 3/8" x
REPLACES 220-849 29"

PART NO. 13-2632 1/4" x
REPLACES 241-926 9-1/2"

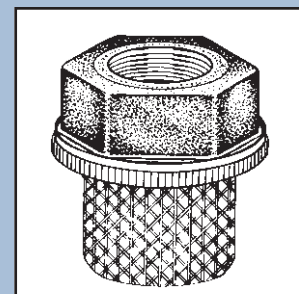

PART NO. 14-1964
REPLACES 235-004

GRACO LIST PRICES ARE BASED ON SINGLE UNIT PRICE IN GRACO U.S. PRICE LIST DATED 12/29/08

To order, contact your local
Paint Spray Equipment Dealer and ask for
Genuine Bedford Replacement Parts.

BEDFORD® Replacement Parts For . . . GRACO Equipment

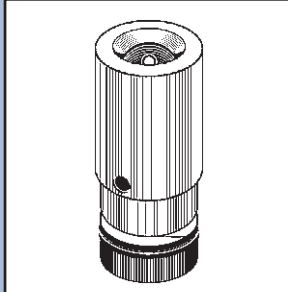

PART NO. 47-2370
REPLACES 235-009

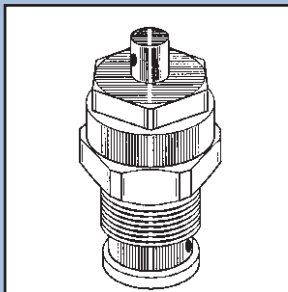

PART NO. 20-2324
REPLACES 235-014

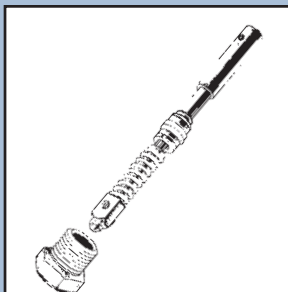

PART NO. 20-1930
REPLACES 235-474

REPLACES GRACO PART NO.	BEDFORD PART NO.	DESCRIPTION	GRACO LIST PRICE (\$)
218-605	—	Replaced by 205-264 (14-151)	—
218-946	20-1488	Gun Adapter Kit	17.20
218-947	—	Order as: (1) pc 181-879 & (1) pc 218-197	—
218-948	—	Replaced by 222-587 (20-1526)	—
220-286	—	Replaced by 222-198 (29-1974)	—
220-366	—	Replaced by 222-588 (20-1499)	—
220-395	20-1355	Kit - 45:1 King, GH733, 20:1 Bulldog	164.50
220-396	20-1387	Kit - 15:1 President (SD)	105.00
220-397	—	Replaced by 223-675 (20-1898)	—
220-398	—	Replaced by 223-674 (20-1920)	—
220-399	20-1328	Kit - 30:1 Bulldog, GH533, 63:1 King	156.00
220-419	12-1314	Stop Bolt	—
220-629	58-1944	Intake Valve - GM5000/10000, Ultra 1500	275.50
220-630	57-1776	Rod - GM5000/10000, Ultra 1500	330.00
220-631	58-1938	Piston Valve - GM5000/10000, Ultra 1500	97.75
220-849	13-2151	Return Hose, 29"x3/8" - GM5000, Ultra 1500	66.25
220-877	20-1500	Kit - GM5000, Ultra 1500, GM10000	123.00
221-077	—	Order as: (1) pc 222-198 (29-1974)	—
221-098	58-2012	Intake Valve - Ultra 400, EM380/390/490	234.00
222-096	—	Replaced by 223-766 (13-1855)	—
222-198	29-1974	Drain Valve (Thumb Screw Type)	84.50
222-437	58-2014	Intake Valve - GM3500, EM590	249.00
222-438	57-1910	Rod - GM3500, Ultra 1000, EM590	254.50
222-587	20-1526	Kit - Ultra 400/500, EM380/390/490	56.00
222-588	20-1499	Kit - Ultra 333/433/1000, GM3500, EM590	68.00
223-341	12-1900	High Pressure Swivel, Teflon Packed	45.20
223-342	20-1935	Kit - Teflon Packed Swivel	44.50
223-365	20-1726	Packing Set - 45:1 King, GH733, 13:1 Sen	82.00
223-367	20-1727	Packing Set - 30:1 Bull, 63:1 King, GH533	78.50
223-371	—	Order as: (10) pcs 166-969 (8-173)	—
223-373	55-2451	Nylon Tip Washers (25), 1/16", Thin	9.40
223-374	55-2452	Nylon Tip Washers (25), 5/32", Thick	9.40
223-540	13-931	25' x 1/4" Airless Hose Assembly	—
223-541	13-932	50' x 1/4" Airless Hose Assembly	—
223-565	58-2306	Piston Valve (SS) - 30:1 President, GH433	143.50
223-589	57-1404	Rod - 30:1 Pres, EH433GT, GH433 (SD)	373.00
223-591	58-2307	Piston Valve (SS) - EH333, 23:1 Monark	110.50
223-603	57-1402	Rod - 23:1 Monark, EH333 (SD)	276.00
223-664	20-2434	Kit - EH433	83.75
223-674	20-1920	Kit - 23:1 Monark, EH333, EH300 (SD)	81.00
223-675	20-1898	Kit - 30:1 President, EH433GT, GH433 (SD)	110.50
223-763	13-314	Outlet Return Hose Assy, 15" - EM400	—
223-766	13-1855	Hose Assy, 29" - EM490, Ultra 400/333	—
223-959	29-1791	3/8" NPT x 1/4" NPT Ball Valve (Teflon)	80.75
223-960	29-1504	3/8" NPT x 3/8" NPT Ball Valve (Teflon)	80.75
224-449	—	Order as: (1) pc 210-657 (29-1440)	—
224-453	55-2454	Tip Filters (5), 100 Mesh, Fine, Enamel	36.80
224-454	55-2457	Tip Filters (5), 60 Mesh, Coarse, Latex	36.80
224-455	55-2483	Filter Elements (2), 50M, Contractor Gun	7.85
224-456	55-2484	Filter Elements (2), 100M, Contractor Gun	7.85

GRACO LIST PRICES ARE BASED ON SINGLE UNIT PRICE IN GRACO U.S. PRICE LIST DATED 12/29/08

BEDFORD® Replacement Parts For . . . GRACO Equipment

To order, contact your local
Paint Spray Equipment Dealer and ask for
Genuine Bedford Replacement Parts.

REPLACES GRACO PART NO.	BEDFORD PART NO.	DESCRIPTION	GRACO LIST PRICE (\$)
224-457	12-2485	1/4" Live Swivel, 3600 PSI, Leather Packed	43.00
224-458	55-2459	Strainers (2), Manifold Filter, 30 Mesh, Long	19.70
224-459	55-2462	Strainers (2), Manifold Filter, 60 Mesh, Long	19.70
224-468	55-2465	Strainers (2), Manifold Filter, 100 Mesh, Long	19.70
224-469	55-2468	Strainers (2), Manifold Filter, 200 Mesh, Long	19.70
224-771	—	Replaced by 235-198 (20-2078)	—
224-775	29-2630	Drain Valve Housing & Stem Assembly	81.50
224-808	58-2212	Piston Valve - 290 Easy, 390st, 390sts	44.60
224-966	58-2215	Intake Valve - 390st, 490st, Ultra 600	80.25
224-968	58-2323	Stem Assembly - Dump Valve	—
224-998	—	Replaced by 235-703 (20-1856)	—
235-004	14-1964	Inlet Filter - 390st	12.30
235-009	47-2370	Kit - Pressure Transducer Assembly	123.50
235-014	20-2324	Kit - Dump Valve	84.50
235-198	20-2078	Kit - Drain Valve	36.80
235-474	20-1930	Kit - Silver/Flex Gun Plus	88.25
235-557	—	Replaced by 218-197 (58-1461)	—
235-635	20-2079	Kit - 30:1 President, GH433	115.00
235-636	20-2310	Kit - 23:1 Monark, EH333 (Leather/Teflon/SS)	86.50
235-703	20-1856	Kit - 390st, 395st, 490st, 495st, Ultra 600	50.75
235-708	57-2099	Cylinder - 395/490/495st, GM3000, Ultra 600	135.50
235-709	57-1946	Rod - 395st, 490st, 495st, Ultra 600	102.50
236-079	47-2631	Poppet Valve Assembly	—
236-495	55-2471	Outlet Filter (2-pack), 30 Mesh, Short	19.70
236-496	55-2474	Outlet Filters (2-pack), 60 Mesh, Short	19.70
236-497	55-2477	Outlet Filters (2-pack), 100 Mesh, Short	19.70
236-498	55-2480	Outlet Filters (2-pack), 200 Mesh, Short	19.70
236-564	20-2258	Kit - GM7000	126.50
236-565	58-2562	Piston Valve - GM7000	97.75
236-566	57-2381	Sleeve - GM7000	282.00
236-567	57-2440	Rod - GM7000	354.00
236-724	20-2311	Kit - 23:1 Monark, EH333 (Teflon/SS)	102.50
236-786	57-2131	Cylinder - 390st, 390sts	128.50
237-239	20-2294	Kit - DuraFlo 750, 33:1 Bull (Leather/Teflon)	163.50
237-241	20-2314	Kit - DuraFlo 750, 33:1 Bulldog (Teflon)	169.00
237-522	13-2556	6' x 1" ID Suction Hose Assy	110.50
237-677	—	Order: Repair Kit 235-014 (20-2324)	—
238-169	47-2261	Ball Holder Assembly - Contractor Gun	17.80
238-286	20-2690	Kit - 5:1 Fireball	97.50
238-358	—	Order: Hose Assy 214-701 (13-792)	—
238-359	—	Order: Hose Assy 214-699 (13-793)	—
238-435	55-2460	Outlet Filters (3-pack), 30 Mesh, Long	26.10
238-436	55-2461	Outlet Filters (25-pack), 30 Mesh, Long	217.50
238-437	55-2463	Outlet Filters (3-pack), 60 Mesh, Long	26.10
238-438	55-2464	Outlet Filters (25-pack), 60 Mesh, Long	217.50
238-439	55-2466	Outlet Filters (3-pack), 100 Mesh, Long	26.10
238-440	55-2467	Outlet Filters (25-pack), 100 Mesh, Long	217.50
238-441	55-2469	Outlet Filters (3-pack), 200 Mesh, Long	26.10
238-442	55-2470	Outlet Filters (25-pack), 200 Mesh, Long	217.50
238-443	55-2472	Outlet Filters (3-pack), 30 Mesh, Short	26.10

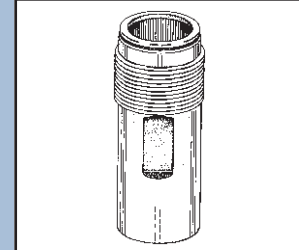

PART NO. 57-2099
REPLACES 235-708

PART NO. 57-2131
REPLACES 236-786



PART NO. 57-2672
REPLACES 240-517

PART NO. 57-2670
REPLACES 240-518

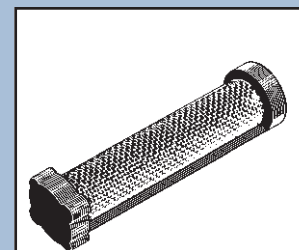

PART NO. 14-2650
REPLACES 243-070

GRACO LIST PRICES ARE BASED ON SINGLE UNIT PRICE IN GRACO U.S. PRICE LIST DATED 12/29/08

To order, contact your local
Paint Spray Equipment Dealer and ask for
Genuine Bedford Replacement Parts.

BEDFORD® Replacement Parts For . . . GRACO Equipment

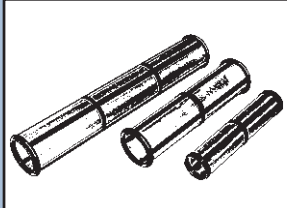

PART NO. 14-2675 60M
REPLACES 246-384 Short
PART NO. 14-2685 60M
REPLACES 243-080 Med
PART NO. 14-2695 60M
REPLACES 244-067 Long

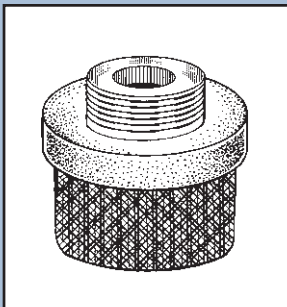

PART NO. 14-2530
REPLACES 243-082

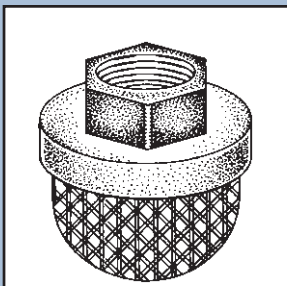

PART NO. 14-2649
REPLACES 246-385

REPLACES GRACO PART NO.	BEDFORD PART NO.	DESCRIPTION	GRACO LIST PRICE (\$)
238-444	55-2473	Outlet Filters (25-pack), 30 Mesh, Short	217.50
238-445	55-2475	Outlet Filters (3-pack), 60 Mesh, Short	26.10
238-446	55-2476	Outlet Filters (25-pack), 60 Mesh, Short	217.50
238-447	55-2478	Outlet Filters (3-pack), 100 Mesh, Short	26.10
238-448	55-2479	Outlet Filters (25-pack), 100 Mesh, Short	217.50
238-449	55-2481	Outlet Filters (3-pack), 200 Mesh, Short	26.10
238-450	55-2482	Outlet Filters (25-pack), 200 Mesh, Short	217.50
238-561	55-2453	Tip Filters (3-pack), 100 Mesh, Fine, Enamel	26.40
238-562	55-2455	Tip Filters (25-pack), 100 Mesh, Fine, Enamel	180.00
238-563	55-2456	Tip Filters (3-pack), 60 Mesh, Coarse, Latex	26.40
238-564	55-2458	Tip Filters (25-pack), 60 Mesh, Coarse, Latex	180.00
238-612	—	Order as: (1) 210-658 (29-1441) Ball Valve	—
238-635	—	Order as: (1) 210-657 (29-1440) Ball Valve	—
238-692	—	Replaced by 235-703 (20-1856)	—
238-769	14-2170	Filter Bags (25-pack)	112.50
239-663	12-2400	1/4" Live Swivel, 3600 PSI, Leather Packed	45.20
239-922	20-2673	Intake Seat Kit - Seat (15/16"), Ball & O-Ring	71.25
239-928	—	Replaced by 248-212 (20-2662)	—
239-932	58-2564	Piston Valve - GMax 3900, UltraMax 795/1095	115.50
239-939	—	Replaced by 244-194 (20-2428)	—
240-150	58-2567	Piston Valve - GMax 5900/10000, Mark IV	97.75
240-248	—	Replaced by 248-213 (20-2663)	—
240-517	57-2672	Rod - UMax 1595, GMax 5900/10000	325.00
240-518	57-2670	Rod - UMax795/1095, UMax II 695/795	268.00
240-521	57-2273	Sleeve - Ultra Max 795/1095, GMax 3900	191.00
240-525	57-2529	Sleeve - Gmax 5900, UltraMax 1595	269.00
240-580	58-2680	Piston Valve - GMax 7900	97.75
240-793	—	Order as: 223-540 (13-931) Airless Assy	—
240-794	—	1/4" x 50' Airless Hose Assy (See 223-541)	—
240-796	—	Order as: 214-703 (13-451) Hose Assy	—
240-797	—	Order as: 214-705 (13-453) Hose Assy	—
240-916	—	Replaced by 246-341 (20-2639)	—
240-919	57-2716	Rod - GMax 7900, GH 200, LL II/III/IV 200	357.00
240-921	57-2531	Sleeve - Gmax 7900, GMx 7900	296.50
241-926	13-2632	Hose Assembly - stPro, 190ES, 295st	27.60
243-070	14-2650	Outlet Filter, 30 Mesh - for Magnum Pumps	—
243-080	14-2685	Outlet Filter, 60 Mesh, Medium Length, Black	9.85
243-081	14-2686	Outlet Filter, 100 Mesh, Medium Length, Blue	9.85
243-082	14-2530	Inlet Strainer - 3/4" GH Thread	—
243-084	20-2719	Contractor Gun Filters, 60 & 100 Mesh (1 ea)	10.50
243-091	20-2359	Kit - 190ES	50.50
243-181	58-2570	Piston Valve - UltraMax 695	77.75
243-190	20-2561	Intake Valve - 395/455/495stPro, UMax 695	48.20
243-192	—	Replaced by 244-194 (20-2428)	—
243-226	14-2687	Outlet Filter, 200 Mesh, Medium Length, Red	16.20
244-067	14-2695	Outlet Filter, 60 Mesh, Long, Black	11.00
244-068	14-2696	Outlet Filter, 100 Mesh, Long, Blue	11.00
244-069	14-2697	Outlet Filter, 200 Mesh, Long, Red	11.00
244-071	14-2694	Outlet Filter, 30 Mesh, Long, Gray	11.00
244-194	20-2428	Kit - 295st, 390, 395/495st Pro, Ult 395/495	57.00

GRACO LIST PRICES ARE BASED ON SINGLE UNIT PRICE IN GRACO U.S. PRICE LIST DATED 12/29/08

BEDFORD® Replacement Parts For . . . GRACO Equipment

To order, contact your local
Paint Spray Equipment Dealer and ask for
Genuine Bedford Replacement Parts.

REPLACES GRACO PART NO.	BEDFORD PART NO.	DESCRIPTION	GRACO LIST PRICE (\$)	GRACO NET PRICE (\$)	BEDFORD NET PRICE (\$)
244-196	—	Replaced by 248-212 (20-2662)	—	—	—
244-198	—	Replaced by 248-213 (20-2663)	—	—	—
244-199	20-2713	Intake Seat (1-1/4") - Seat, Ball & O-Ring	106.00	74.20	48.23
244-216	—	Order as: 240-518 (57-2670)	—	—	—
244-217	—	Order as: 240-517 (57-2672)	—	—	—
244-782	13-2533	50' x 3/8" 3000 PSI Pres Washer Hose w/QD	—	—	58.50
244-783	13-2543	50' x 3/8" 4000PSI Pres Washer Hose w/QD	187.00	130.90	61.75
244-890	55-2641	Teflon O-Rings (10-pack)	37.20	26.04	16.93
244-892	55-2647	Teflon O-Rings (10-pack)	37.20	26.04	16.93
244-893	55-2645	Teflon O-Rings (10-pack)	37.20	26.04	16.93
244-894	55-2643	Teflon O-Rings (10-pack)	42.50	29.75	19.34
244-895	55-2536	Teflon O-Rings (10-pack)	31.80	22.26	14.47
244-896	55-2537	Teflon O-Rings (10-pack)	31.80	22.26	14.47
244-955	—	Replaced by 246-341 (20-2639)	—	—	—
245-414	—	Order as: 240-919 (57-2716)	—	—	—
246-341	20-2639	Kit - GH200, GMax 7900, HydraMax 225	129.50	90.65	56.98
246-382	14-2676	Outlet Filter, 100 Mesh, Short, Blue	6.85	4.80	2.28
246-384	14-2675	Outlet Filter, 60 Mesh, Short, Black	6.85	4.80	2.28
246-385	14-2649	Inlet Strainer, 7/8" UNF Thd - Ultra 395/495	9.05	6.34	2.89
246-429	20-2757	Intake Valve - Ultra 395/495/595/695	108.00	75.60	49.14
248-206	—	Order as: 240-518 (57-2670)	—	—	—
248-207	—	Order as: 240-517 (57-2672)	—	—	—
248-209	—	Order as: 240-521 (57-2273)	—	—	—
248-210	—	Order as: 240-525 (57-2529)	—	—	—
248-212	20-2662	Kit - UltraMax II 695/795, GMax II 3900	73.75	51.63	32.45
248-213	20-2663	Kit - UMax II 1095/1595, GMax II 5900/10000	88.00	61.60	38.72
248-502	—	Order as: 239-932 (58-2564)	—	—	—
248-979	—	Order as: 240-921 (57-2531)	—	—	—
249-000	—	Order as: 240-919 (57-2716)	—	—	—
249-197	—	Order as: 218-131 (14-1484) 50M Filter	—	—	—
249-198	—	Order as: 218-133 (14-1485) 100M Filter	—	—	—
249-199	—	Order as: 287-032 (14-2664) 60M Filter	—	—	—
249-200	—	Order as: 287-032 (14-2665) 100M Filter	—	—	—
287-031	20-2701	Kit - Contractor II & FTx II Spray Guns	62.75	43.93	29.76
287-032	14-2664	Gun Filter, 60 Mesh - Contractor II / FTxII	7.00	4.90	1.80
287-033	14-2665	Gun Filter, 100 Mesh - Contractor II / FTxII	7.00	4.90	1.80
287-034	14-2648	Gun Filters, 60 & 100 Mesh - Contractor II	13.60	9.52	4.35
287-078	—	Order as (1) each: 243-091, 218-197, 176-751	—	—	—
287-079	—	Order as 1 each: 222-588, 218-037, 178-945	—	—	—
801-568	12-2524	3/8" NPT(f) Quick Disc Plug, Stainless Steel	20.20	14.14	7.88
801-569	12-2526	3/8" NPT(f) Quick Disconnect Coupler, Brass	20.20	14.14	6.29
803-157	12-2527	3/8" NPT(f) Quick Disc Coupler, Stainless St	77.00	53.90	27.45
M70628	54-25	Cup Lid Gasket, 2 Quart	—	—	1.24

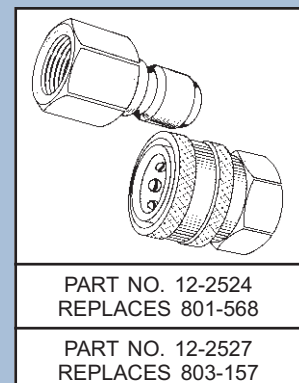
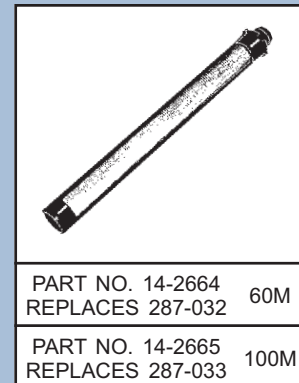
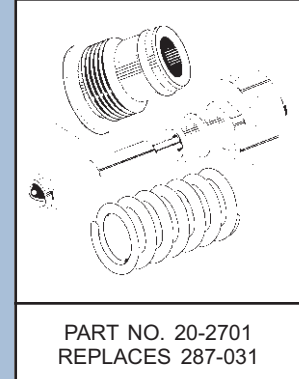

GRACO LIST PRICES ARE BASED ON SINGLE UNIT PRICE IN GRACO U.S. PRICE LIST DATED 12/29/08

To order, contact your local
Paint Spray Equipment Dealer and ask for
Genuine Bedford Replacement Parts.

BEDFORD® Replacement Parts For . . . H.E.R.O. Equipment

Quick Reference for . . . H.E.R.O. Pumps

PUMP MODEL	For the Bedford Replacement Part, refer to the following H.E.R.O. component P/N's:									
	DIAPHRAGM ASSEMBLY	INTAKE REPAIR PARTS					OUTGO REPAIR PARTS			
		HEAD & SEAT ASSEMBLY	INTAKE REPAIR KIT	SEAT	BALL	CAGE	OUTGO REPAIR KIT	SEAT	BALL	CAGE
75, 75W, 80, 90, 300S, 300SL, 2000, 3000 Diaphragm Pumps	4-22C	4-4B	4-6652	6	17S 17	183S 18A	4-6655	11A-45 11A-4	11A-5S 11A-5	11A-6
300GS, 1150G, 1150GS Diaphragm Pumps	4-622C	—	4-6653	6	17S	183S	4-6656 (See Note)	11A-45	11A-5S	11A-6
1000NC, 1100C, 1100NC Diaphragm Pumps	4-22C	4-4B	4-6651	6	17S 17	183S 18A	4-6655	11A-45 11A-4	11A-5S 11A-5	11A-6

Note: When ordering 4-6656 "Outgo Repair Kit", order 11A-45 "Outgo Seat" separately.

PUMP MODEL	Complete Fluid Section Repack / Repair Kits		
	REPLACES H.E.R.O. PART NO.	BEDFORD PART NO.	CONTAINS THE FOLLOWING ITEMS:
75, 75W, 80, 90, 300S, 300SL, 2000, 3000 Diaphragm Pumps	4-10-22-1502	20-1932	5 Intake O-Ring 17S Corrosion Resistant Intake Ball 4-22CRK Diaphragm Repair Kit 7C Outgo Valve Washer 11A-3CP Outgo Seat Crush Washer 11A-5 Nylon Outgo Ball
300GS, 1150G, 1150GS Diaphragm Pumps	4-10-22-1507	20-1934	5 Intake O-Ring 17S Corrosion Resistant Intake Ball 4-622CRK Diaphragm Repair Kit 7C Outgo Valve Washer 11A-3CP Outgo Seat Crush Washer 11A-5S Corrosion Resistant Outgo Ball
1000NC, 1100C, 1100NC Diaphragm Pumps	4-10-22-1503	20-1933	5 Intake O-Ring 17 Nylon Intake Ball 4-22CRK Diaphragm Repair Kit 7C Outgo Valve Washer 11A-3CP Outgo Seat Crush Washer 11A-5 Nylon Outgo Ball
400, 401, 500, 501, 6000 Piston Pumps	4-02-40-2510	20-2051	02-40-2003 Intake Valve O-Ring 02-40-2004 Lower Ball (Intake) 02-40-2007 Crush Washer 02-40-2010 Backup Washer 02-40-2018 Upper Ball (Piston) 4-02-40-2503 Upper Packing Set 4-02-40-2509 Lower packing Set

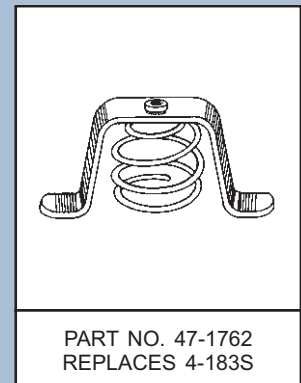
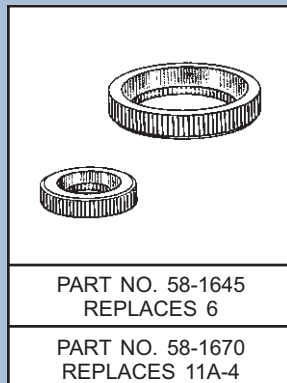
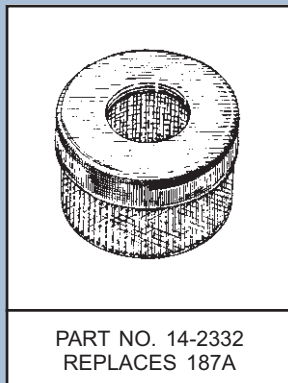

BEDFORD® Replacement Parts For . . . H.E.R.O. Equipment

To order, contact your local
Paint Spray Equipment Dealer and ask for
Genuine Bedford Replacement Parts.

REPLACES H.E.R.O. PART NO.	BEDFORD PART NO.	DESCRIPTION	H.E.R.O. LIST PRICE (\$)
02-22-2006	0-2003	Intake O-Ring, Urethane	4.83
02-22-2007	0-2004	Intake O-Ring, Viton	3.63
02-22-2009	10-2005	Intake Washer, Crush	5.93
02-40-2003	15-2033	Intake Valve O-Ring, Teflon	4.75
02-40-2004	9-2034	Ball, Intake Valve	2.37
02-40-2007	10-2035	Intake Washer, Crush	3.40
02-40-2010	10-2036	Backup Washer, Piston Valve	6.08
02-40-2018	9-2037	Ball, Piston Valve	1.42
02-40-2019	57-2334	Rod - 400, 500, 6000 Pumps	—
1-3-WHIP	—	Replaced by 3-WHIPEND (13-792)	—
10-55-4402	58-2232	Diffuser Assy, ASM 400 Gun, "F" Thread	34.50
10-55-4404	47-2227	Ball & Plunger Assembly, ASM 400 Gun	38.69
10-55-4405	47-2229	Ball Holder Assembly, ASM 400 Gun	21.25
10-55-4412	6-2223	External Seal, ASM 400 Gun	2.07
10-55-4425	55-2226	Valve Stem Locknut (3-pack), ASM 400 Gun	5.25
10-55-4426	20-2233	Kit - ASM 400 (Diffuser & Ball Holder)	46.91
10-55-4427	20-2234	Kit - ASM 400 (Diffuser, Ball Holder, Plunger)	64.61
10-55-4428	47-2235	Plunger Assembly, ASM 400 Gun	25.39
114	13-932	50' x 1/4" Airless Hose Assembly	59.00
115	13-931	25' x 1/4" Airless Hose Assembly	51.94
117	13-453	50' x 3/8" Airless Hose Assembly	174.90
11A-3CP	10-1591	Washer, Outgo, Copper, Crush	1.48
11A-4	58-1670	Seat, Outgo Valve, 3/8"	47.47
11A-45	58-1740	Seat, Outgo Valve (90°)	47.47
11A-5	9-1592	Ball, Outgo, Nylon, 3/8"	2.02
11A-5S	9-1593	Ball, Outgo, 3/8" Corrosion Resistant	4.06
11A-6	17-1705	Cage, Outgo Ball	13.18
11A-7	23-1600	Spring, Outgo Valve	12.53
17	9-1594	Ball, Intake, Nylon, 3/4"	4.06
17S	9-1595	Ball, Intake, 3/4" Corrosion Resistant	9.21
187A	14-2332	Inlet Strainer - 3/4" NPT Thread	—
187F	—	Order as: 187A (14-2332)	—
18A	17-1708	Cage, Intake Ball	18.44
19A	23-1627	Spring, Intake Valve, 1-7/8"	14.67
27C-2	9-1728	Ball, PC Valve	2.13
3-WHIPEND	13-792	3' x 3/16" Airless Hose Assembly	25.85
4-02-40-2019	—	Order as: (1) 02-40-2019 (57-2334)	—
4-02-40-2503	20-2038	Upper Packing Set - 400, 500, 6000	—
4-02-40-2509	20-2044	Lower Packing Set - 400, 500, 6000	—
4-02-40-2510	20-2051	Kit - 400, 500, 6000 Series Pumps	52.21
4-10-22-1502	20-1932	Kit - 75W, 80, 90, 300S/SL, 2000	49.46
4-10-22-1503	20-1933	Kit - 1100NC, 1000NC	47.24
4-10-22-1507	20-1934	Kit - 1150G, 1150GS	60.19
4-183S	47-1762	Intake Ball Cage, Spring Loaded	23.43
4-22C	20-1725	Diaphragm Assembly - Electric Models	55.39
4-22CRK	20-1632	Kit - Diaphragm Repair, Electric Models	23.59
4-4B	47-1953	Intake Head Assembly (SS) - for 3/8" bolts	279.92
4-606RK	20-2538	Kit - Prime/Bleed Valve	37.10
4-622C	20-1888	Diaphragm Assembly - Gas Models	88.21
4-622CRK	20-1889	Kit - Diaphragm Repair - Gas Models	31.57

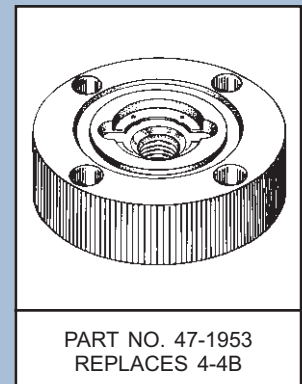
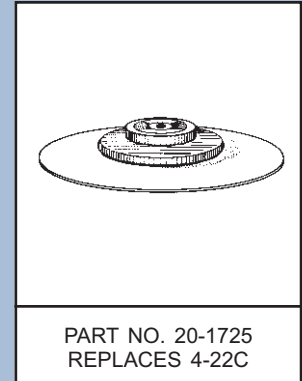

H.E.R.O. LIST PRICES ARE BASED ON SINGLE UNIT PRICE IN H.E.R.O. U.S. PRICE LIST DATED 1/1/06

To order, contact your local
Paint Spray Equipment Dealer and ask for
Genuine Bedford Replacement Parts.

BEDFORD® Replacement Parts For . . . H.E.R.O. Equipment

Replacement Parts for . . . H.E.R.O. (continued)

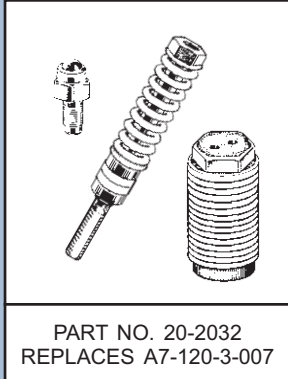

REPLACES H.E.R.O. PART NO.	BEDFORD PART NO.	DESCRIPTION	H.E.R.O. LIST PRICE (\$)
4-6650	20-1722	Kit - Intake Repair	37.10
4-6651	20-1729	Kit - Intake Overhaul	108.65
4-6652	20-1763	Kit - Intake Repair	59.36
4-6653	20-1764	Kit - Intake Overhaul	119.25
4-6654	20-1723	Kit - Outgo Repair	32.72
4-6655	20-1724	Kit - Outgo Overhaul	80.19
4-6656	20-1721	Kit - Outgo Repair	11.09
5	0-1588	O-Ring	2.11
5V	0-1589	Intake O-Ring, Viton	3.66
6	58-1645	Seat, Intake Valve, 3/4"	59.29
7C	10-1590	Washer, Outgo Valve, Copper	1.48
A7-120-11	58-2001	Valve Spring Unit - 007 Gun	94.34
A7-120-2-007	20-2031	Kit - 007 Gun (Ball Holder & Seal)	—
A7-120-21	19-2007	Lock nut	.32
A7-120-3-007	20-2032	Kit - 007 Gun (Complete)	—
A7-120-33	2-2029	Seal, Teflon	—
A7-120-35	58-2022	Valve Seat - 007 Gun	100.70
A7-120-37	58-2024	Ball Holder	79.50

H.E.R.O. LIST PRICES ARE BASED ON SINGLE UNIT PRICE IN H.E.R.O. U.S. PRICE LIST DATED 1/1/06

To order, contact your local
Paint Spray Equipment Dealer and ask for
Genuine Bedford Replacement Parts.

BEDFORD® Replacement Parts For . . . SHARPE Equipment

Replacement Parts for . . . SHARPE

REPLACES SHARPE PART NO.	BEDFORD PART NO.	DESCRIPTION	SHARPE LIST PRICE (\$)
10326	8-1807	Head Attach Gasket (1-20-28)	4.20
10332	44-1800	Trigger Shaft (1-20-34)	7.40
10333	19-1801	Trigger Screw (1-20-35)	4.20
16000	20-1794	Kit - 71 & 75PI Guns (1-70RK)	33.99
16100	8-1802	Tip Gasket (1-71-01)	4.20
16137	55-1803	Packings, Set of 2 (1-71-11A)	4.20
16139	8-1804	Packing (1-71-13)	4.20
16147	12-1805	Packing Nut (1-71-21)	5.25
16150	23-1806	Needle Spring (1-71-24)	4.20
16162	8-1808	Air Valve Packing (1-71-37)	4.20
16163	8-1809	Gasket (1-71-38)	4.20
16166	47-1810	Air Valve Assembly (1-71-41X)	—
16167	23-1811	Air Valve Spring (1-71-42)	4.20
16175	19-1812	"E" Clip (1-71-50)	4.20
25032	23-1813	Needle Spring (1-775-24)	4.20
25066	47-1814	Air Valve Assembly (1-775-41X)	11.60
25196	20-1795	Kit - 775PI Gun (1-775RK)	35.99

SHARPE LIST PRICES ARE BASED ON SINGLE UNIT PRICE IN SHARPE U.S. PRICE LIST DATED 12/30/08

BEDFORD® Replacement Parts For . . . TITAN / SPEEFLO Equipment

To order, contact your local
Paint Spray Equipment Dealer and ask for
Genuine Bedford Replacement Parts.

Quick Reference for . . . SPEEFLO Pumps

SPEEFLO MODEL NUMBER	SPEEFLO PUMP MODEL DESCRIPTION	TECH REF *
121-201	Ensign 12:1	150:16:1
121-202	Ensign 12:1	150:16:1
121-300	Ensign 12:1	150:16:1
121-301	Ensign 12:1	150:16:1
121-302	Ensign 12:1	150:16:1
121-321	Ensign 12:1	150:16:1
121-322	Ensign 12:1	150:16:1
121-323	Ensign 12:1	150:16:1
231-140	Motor Pump Assy 6:1	150:16:1
231-172	Motor Pump Assy 3:1	250:16
231-174	Motor Pump Assy 3:1	250:16
231-175	Motor Pump Assy 3:1	250:16
231-176	Motor Pump Assy 3:1	250:16
310-021	Trident 3:1	250:16
310-026	Trident 3:1	250:16
310-027	Trident 3:1	250:16
310-028	Trident 3:1	250:16
310-035	Motor Pump Assy 3:1	250:16
310-036	Wall Mt. Recirc. Pump 3:1	250:16
310-038	Trident 3:1	250:16
310-039	Trident 3:1	250:16
310-041	Trident 3:1	250:16
310-045	Portable Trans. Pump 3:1	250:16
310-046	Portable Supply Pump 3:1	250:16
310-047	Portable Supply Pump 3:1	250:16
310-049	Wall Mt. Trans. Pump 3:1	250:16
310-135	Motor Pump Assembly 3:1	250:12
310-235	Motor Pump Assembly 3:1	250:12
310-436	Motor Pump Assy SS 3:1	250:17
310-580	Trident 3:1	250:16
310-582	Trident 3:1	250:16
310-598	Trident 3:1	250:16
310-599	Trident 3:1	250:16
312-041	Transfer Pump SS 3:1	250:17
312-045	Transfer Pump SS 3:1	250:17
312-580	Bung Mt. Trans. SS 3:1	250:17
312-589	Bung Mt. Trans. SS 3:1	250:17
312-591	Bung Mt. Trans. SS 3:1	250:17
312-600	Drum Mt. Trans. SS 3:1	250:17
315-588	Motor Pump Assembly 3:1	250:16
315-589	Trident 3:1	250:16
315-590	Motor Pump Assembly 3:1	250:16
315-591	Bung Mt. Trans. Pump 3:1	250:16
323-140	Motor Pump Assy 12:1	150:16:1
323-173	Motor Pump Assembly 6:1	250:17
323-174	Motor Pump Assembly 6:1	250:17
323-175	Motor Pump Assembly 6:1	250:17
323-176	Motor Pump Assembly 6:1	250:17
323-694	Motor Pump Assy 35:1	150:18
328-300	Ensign 35:1	150:18
328-301	Ensign 35:1	150:18
328-302	Ensign 35:1	150:18
328-304	Ensign 35:1	150:18
328-305	Ensign 35:1	150:18
328-306	Ensign 35:1	150:18
328-308	Ensign 35:1	150:18
328-320	Ensign 35:1	150:18
335-500	PowrTwin 3500	152:07
335-501	PowrTwin 3500	152:07
335-502	PowrTwin 3500	152:07
335-503	PowrTwin 3500	152:07
343-151	Ranger 3:1	250:12
343-152	Ranger 3:1	250:12
344-151	Ranger 3:1	250:12
344-152	Ranger 3:1	250:12
349-151	Ranger 3:1	250:12
349-152	Ranger 3:1	250:12
351-068	Ensign 35:1	150:18
355-201	Ensign 35:1	150:18
355-202	Ensign 35:1	150:18
359-201	Ensign 35:1	150:18
359-202	Ensign 35:1	150:18
427-804	PowrTwin	150:16
427-812	PowrTwin	150:16
428-055	Motor Pump Assy 3:1	150:16
428-800	PowrTwin	150:16
428-802	PowrTwin	150:16
428-810	PowrTwin Classic	150:16:1
428-812	PowrTwin Classic	150:16:1
428-822	PowrTwin Classic	150:16:1

SPEEFLO MODEL NUMBER	SPEEFLO PUMP MODEL DESCRIPTION	TECH REF *
428-832	PowrTwin Classic	150:16:1
428-835	PowrTwin Classic	150:16:1
428-838	PowrTwin Classic	150:16:1
428-890	PowrTwin Classic	150:16:1
428-894	PowrTwin Classic	150:16:1
429-800	PowrTwin Classic	150:16:1
429-802	PowrTwin Classic	150:16:1
429-803	PowrTwin Classic	150:16:1
429-822	PowrTwin Classic	150:16:1
429-850	HydraTech 1.5 HP Deluxe	150:16:1
429-851	HydraTech 1.5 HP	150:16:1
429-852	HydraTech 2 HP Deluxe	150:16:1
429-853	HydraTech 2 HP	150:16
431-145	Motor Pump Assembly 3:1	150:16:1
431-146	Motor Pump Assembly 3:1	150:16:1
431-182	Motor Pump Assy 1.5:1	150:12
431-184	Motor Pump Assy 1.5:1	150:10
431-185	Motor Pump Assy PZ1.5:1	150:12/13
434-802	HydraPro III	150:12/13
434-805	HydraPro IV	150:12
434-810	HydraPro IV	150:12
434-812	HydraPro IV	150:12
434-813	HydraPro Super	150:12
434-814	HydraPro Super	150:12
434-815	HydraPro Super	150:12
434-816	HydraPro Super	150:12
437-802	Boss Portable 8 HP	150:12
437-812	Boss Portable 7.5 HP	150:12/13
438-802	HydraPro III 8 HP	150:12/13
441-140	Motor Pump Assembly 6:1	150:11
441-182	Motor Pump Assembly 3:1	150:12
441-183	Motor Pump Assembly 3:1	150:12
441-184	Motor Pump Assembly 3:1	150:12
441-185	Motor Pump Assembly 3:1	150:12
446-800	PowrTwin Scout	150:19
446-802	PowrTwin Scout	150:19
446-810	PowrTwin Scout	150:19
446-812	PowrTwin Scout	150:19
446-815	PowrTwin Super Scout	150:19
446-818	PowrTwin Super Scout	150:19
446-825	PowrTwin Super Scout	150:19
446-835	PowrTwin Super Scout	150:19
446-837	PowrTwin Super Scout	150:19
446-838	PowrTwin Super Scout	150:19
446-891	PowrTwin Super Scout	150:19
446-897	PowrTwin Super Scout	150:19
447-800	PowrTwin Jr.	150:19
447-802	PowrTwin Jr.	150:19
447-807	PowrTwin Jr.	150:19
447-808	PowrTwin Jr.	150:19
447-810	PowrTwin Jr.	150:19
447-811	PowrTwin Jr.	150:19
447-812	PowrTwin Jr.	150:19
447-814	PowrTwin Jr.	150:19
447-816	PowrTwin Jr.	150:19
447-819	PowrTwin Jr.	150:19
447-821	PowrTwin Jr.	150:19
447-890	PowrTwin Jr.	150:19
448-450	PowrTwin 4500	152:07
448-453	PowrTwin 4500	152:07
448-455	PowrTwin 4500	152:07
448-456	PowrTwin 4500	152:07
448-890	PowrTwin 4500	152:07
449-800	PowrTwin 5500	152:03
449-803	PowrTwin 5500	152:03
449-804	PowrTwin 5500	152:03
449-805	PowrTwin 5500	152:03
449-807	PowrTwin 5500	152:03
449-808	PowrTwin 5500	152:03
449-890	PowrTwin 5500	152:03
525-140	Motor Pump Assy 30:1	150:16:1
525-145	Motor Pump Assy 30:1	150:16:1
525-146	Motor Pump Assy 30:1	150:16:1
525-147	Motor Pump Assy 30:1	150:16:1
525-171	Motor Pump Assy 15:1	250:16
525-173	Motor Pump Assy 15:1	250:16
525-176	Motor Pump Assy 15:1	250:16
525-178	Motor Pump Assembly	250:17
530-021	Atlas 30:1	150:16:1
530-152	Atlas 30:1	150:16:1

SPEEFLO MODEL NUMBER	SPEEFLO PUMP MODEL DESCRIPTION	TECH REF *
530-153	Atlas 30:1	150:16:1
530-154	Atlas 30:1	150:11
530-183	Atlas 30:1	150:11
530-320	Atlas 30:1	150:16:1
530-321	Atlas 30:1	150:16:1
530-322	Atlas 30:1	150:16:1
530-323	Atlas 30:1	150:16:1
530-324	Atlas 30:1	150:16:1
530-331	Atlas 30:1	150:16:1
530-353	Atlas 30:1	150:11
530-521	Atlas 30:1	150:16:1
530-561	Atlas 30:1	150:16:1
530-562	Atlas 30:1	150:16:1
530-921	Atlas 30:1	150:16:1
530-961	Atlas 30:1	150:16:1
530-962	Atlas 30:1	150:16:1
612-035	Motor Pump Assy SS 6:1	250:17
643-302	Ranger 3:1	250:12
643-352	Ranger 3:1	250:12
644-302	Ranger 3:1	250:12
644-352	Ranger 3:1	250:17
731-152	Motor Pump Assy	150:13
731-183	PowerMastic Pump 40:1	150:13
731-186	PowerMastic Pump 40:1	150:13
731-315	Commander 30:1 PZ	150:13
731-316	Commander 30:1 PZ	150:13
731-330	Commander 30:1	150:12
731-331	Commander 30:1	150:12
731-332	Commander 30:1	150:12
731-334	Commander 30:1	150:12
731-341	Commander 30:1	150:12
731-342	Commander 30:1	150:12
731-344	Commander 30:1	150:12
731-352	Commander 30:1	150:12
731-353	Commander 30:1	150:12
731-441	Commander 30:1	150:12
731-531	Commander 30:1	150:12
731-551	Motor Pump Assembly	150:12
731-931	Commander 30:1	150:12
742-140	Motor Pump Assy 60:1	150:16
742-141	Motor Pump Assy 60:1	150:16
742-183	Motor Pump Assy 30:1	150:12
742-186	Motor Pump Assy 30:1	150:12
761-155	Motor Pump Assembly	150:11
761-300	Commander 60:1	150:11
761-301	Commander 60:1	150:11
761-303	Commander 60:1	150:11
761-304	Commander 60:1	150:11
761-311	Commander 60:1	150:11
761-312	Commander 60:1	150:11
761-411	Commander 60:1	150:11
761-421	Commander 60:1	150:11
850-140	Motor Pump Assy 80:1	150:11
850-183	Motor Pump Assy	150:12
941-052	Motor Pump Assy	150:12
941-054	Motor Pump Assy Long	150:12
941-183	Admiral 40:1	150:12
941-321	Admiral 40:1	150:12
941-323	Admiral 40:1	150:12
941-330	Commander 40:1	150:12
941-331	Admiral 40:1	150:12
941-332	Commander 40:1	150:12
941-334	Commander 40:1	150:12
941-341	Commander 40:1	150:12
941-342	Commander 40:1	150:12
941-421	Admiral 40:1	150:12
941-441	Admiral 40:1	150:12
941-531	Admiral 40:1	150:12

* NOTE: To find the appropriate repair kit and packing sets related to your pump, locate the pump model number in the table above. Match the number in the TECH REF column to that in the chart on the next page.

Always consult the OEM instruction sheet that came with your unit to determine the proper packing material compatible with the fluid being sprayed.

To order, contact your local
Paint Spray Equipment Dealer and ask for
Genuine Bedford Replacement Parts.

BEDFORD® Replacement Parts For . . . TITAN / SPEEFLO Equipment

Quick Reference for . . . SPEEFLO Air & Hydraulic Motors

MOTOR MODELS	PUMP MODEL NAME	TECH REF	MOTOR SERVICE KIT	
			REPLACES SPEEFLO P/N	BEDFORD P/N
742-557 "Commander" Air Motor	AirMastic 10 PowrMastic 40 Commander: 20 / 30 / 45 / 60	150:08	742-051	20-1218
850-555 "Admiral" Air Motor	Admiral: 30 / 40 / 60 Alaskan AirMastic 14 Big 440 Commander 40 PowrMastic Super	150:04	850-050	20-1219
Series 235, 236 & 335 Hydraulic Motors	PowrTwin: JR / Scout / 3500 / 4500 / 5500 / 4900 / 6900 / 8900 / 10,000 / 12,000 PowrLiner: 4000 / 5000 / 6000	152:02	235-050	20-2439

Quick Reference for . . . SPEEFLO Pumps

PUMP MODEL	TECH REF	COMPONENT DESCRIPTIONS	REPLACES SPEEFLO PART NO.	BEDFORD PART NO.	NOTES
183-554 & 181-556	150:10	Minor Repair Kit	182-050	20-579	Leather & Teflon
		Piston Rod	185-984	57-2272	
		Piston Valve	182-921	58-2605	
Commander 60 PowrTwin	150:11 150:16	Minor Repair Kit	140-051 140-052 140-053	20-572 20-1215 20-1871	Leather & polyethylene Leather & Teflon Teflon
		Piston Rod	138-917	57-2180	
		Piston Valve	143-945	58-2327	
Admiral 40 Boss Commander 30 & 40 HydraPro III & IV HydraPro Super PowrMastic 40	150:12 150:12/13 150:13	Minor Repair Kit	185-050 185-051 185-052	20-1318 20-1319 20-1691	Leather & polyethylene Leather & Teflon Teflon
		Piston Rod	185-984	57-2272	
		Cylinder	183-930	57-2341	
		Piston Valve	182-921	58-2605	
Atlas 30 Ensign 12 PowrTwin Classic PowrTwin II	150:16:1	Minor Repair Kit	145-051 145-052 148-050	20-1471 20-1472 20-1854	Leather & polyethylene Leather (7) & Teflon (2) Leather (4) & Teflon (5)
		Piston Rod	138-917	57-2180	
		Cylinder	145-922	57-2345	
		Piston Valve	143-945	58-2327	
148 Series Pumps	150:16:4	Minor Repair Kit	148-051 148-050	20-1860 20-1854	Teflon & polyethylene Leather & Teflon
PowrTwin Jr Scout & Super Scout	150:19	Minor Repair Kit	106-050	20-1685	Leather & Polyethylene
		Piston Valve	106-011	58-2405	
Hydra M 4000	150:20	Minor Repair Kit	245-050	20-2396	Leather & polyethylene
PowrTwin 5500 PowrLiner 6000 PowrTwin 6900	152:03	Minor Repair Kit	143-050	20-1853	Leather & polyethylene
		Piston Rod	143-117	57-2274	
		Cylinder	143-822	57-2329	
		Piston Valve	143-945	58-2327	
PowrLiner 4000 PowrTwin 3500 / 4500 PowrTwin 4900 PowrLiner 5000	152:07	Minor Repair Kit	107-051	20-1857	Leather & polyethylene
		Piston Rod	107-029	57-2270	
		Cylinder	107-936	57-2343	
		Piston Valve	106-011	58-2405	
Ranger 3	250:12	Minor Repair Kit	174-050 174-051 174-055	20-573 20-865 20-1699	Leather & Teflon Leather & Teflon Leather & Teflon / stainless steel
Trident 3 Ranger 3	250:16 250:17	Minor Repair Kit	174-052 174-056 174-058	20-1692 20-1701 20-1206	Teflon Leather & Teflon Teflon
PowrTwin 8900 PowrTwin 10,000 PowrTwin 12,000	—	Minor Repair Kit	144-050	20-2152	Leather & polyethylene
		Piston Rod	144-117	57-2594	
		Cylinder	144-822	57-2587	
		Piston Valve	143-945	58-2327	
PowrLiner 3100 GXC	—	Repair Kit	730-401	20-2242	Polyethylene
		Piston Rod	704-560	57-2720	
		Upper Ball Seat (outlet seat)	762-134	58-2435	
		Lower Ball Seat (inlet seat)	762-137	58-2437	

NOTE: Always consult the OEM instruction sheet that came with your unit to determine the proper repair kit for your pump and material requirements.

BEDFORD® Replacement Parts For . . . TITAN / SPEEFLO Equipment

To order, contact your local
Paint Spray Equipment Dealer and ask for
Genuine Bedford Replacement Parts.

Quick Reference for . . . TITAN Pumps

PUMP MODEL	COMPONENT DESCRIPTIONS	REPLACES TITAN PART NO.	BEDFORD PART NO.	NOTES
330 330HP	Repair Kit	704-113	20-2397	
	Piston Rod	704-560	57-2720	
	Outlet Seat	704-558	58-2691	
	Inlet Seat	762-137	58-2437	
	Outlet Filter	500-200-03	14-2171	30 mesh, twin-pack
		500-200-06	14-2172	60 mesh, twin-pack
		500-200-10	14-2173	100 mesh, twin-pack
Inlet Filter	700-805	14-2081	3/4" thread	
440e * 447ex * 660ex ** 660GX ** ProMark 690 **	Repair Kit	702-130	20-2208	
		702-140	20-2209	Includes inlet and outlet valve plates
	Piston Rod	700-580	57-2264	
	Inlet Seat	700-608	58-2134	
	Outlet Filter Note: match */** series shown in description	500-200-03	14-2171	* 30 mesh, twin-pack
		500-200-06	14-2172	* 60 mesh, twin-pack
		500-200-10	14-2173	* 100 mesh, twin-pack
		730-067-30	14-2096	** 30 mesh
		730-067	14-2097	** 60 mesh
		730-067-10	14-2098	** 100 mesh
	Inlet Filter	700-805	14-2081	3/4" thread, Low Rider
710-046		14-2082	1-5/16" thread, High Rider	
440HP * 640i * 440HPx * 660HPx * 440i * 690HP ** 440XC * 660XC * 447HP * 690GXC * 447HPx * 690HPG * 550XC * 3205E **	Repair Kit	730-401	20-2242	
	Piston Rod	704-560	57-2720	
	Outlet Seat	704-558	58-2691	
	Inlet Seat	762-137	58-2437	
	Outlet Filter Note: match */** series shown in description	500-200-03	14-2171	* 30 mesh, twin-pack
		500-200-06	14-2172	* 60 mesh, twin-pack
		500-200-10	14-2173	* 100 mesh, twin-pack
		730-067-30	14-2096	** 30 mesh
		730-067	14-2097	** 60 mesh
		730-067-10	14-2098	** 100 mesh
	Inlet Filter	700-805	14-2081	3/4" thread, Low Rider
		710-046	14-2082	1-5/16" thread, High Rider
	E-20 * G-55 * 1200GXC ** 1200HPG ** ProMark 5500 *	Repair Kit	761-175	20-2210
Outlet Seat		761-079	20-2115	
Inlet Seat		761-080	20-2117	
Outlet Filter Note: match */** series shown in description		761-043	14-2101	* 60 mesh
		920-004	14-2265	** 50 mesh
		920-005	14-2266	** 100 mesh
Inlet Filter		710-046	14-2082	1-5/16" thread, High Rider
E-15 * G-40 * 1100HPx ** 1100XC **	Repair Kit	762-175	20-2211	
	Outlet Seat	762-134	58-2435	
	Inlet Seat	762-137	58-2437	
	Outlet Filter Note: match */** series shown in description	761-043	14-2101	* 60 mesh
		920-004	14-2265	** 50 mesh
		920-005	14-2266	** 100 mesh
	Inlet Filter	710-046	14-2082	1-5/16" thread, High Rider

Quick Reference for . . . TITAN Spray Guns

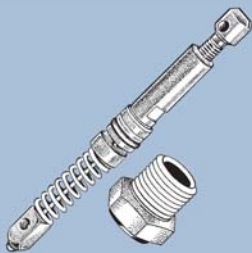

SPRAY GUN MODEL	SPRAY GUN REPAIR KITS	
	REPLACES TITAN PART NO.	BEDFORD PART NO.
LX-80	580-034	20-2095
SGX-20	520-025	20-2088
HVLP GUNS: 200, 300, 350, 400	770-389	20-2150



To order, contact your local
Paint Spray Equipment Dealer and ask for
Genuine Bedford Replacement Parts.

BEDFORD® Replacement Parts For . . . TITAN / SPEEFLO Equipment

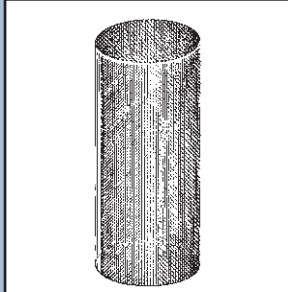

PART NO. 14-905
REPLACES 103-624

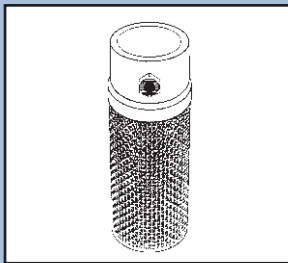

PART NO. 14-2297
REPLACES 103-625

PART NO. 14-2299
REPLACES 103-627

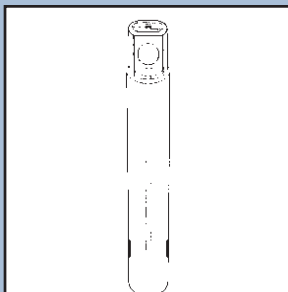

PART NO. 57-2274
REPLACES 143-117

REPLACES TITAN PART NO.	BEDFORD PART NO.	DESCRIPTION	TITAN LIST PRICE (\$)
103-624	14-905	Screen, Inlet Sump - 50 Mesh	10.92
103-625	14-2297	Rock Catcher Assembly - 1" OD Tube	22.87
103-627	14-2299	Rock Catcher Assembly - 1-1/4" OD Tube	23.49
103-628	14-904	Screen, Inlet Sump - 30 Mesh	11.26
106-002	20-1673	Packing Set (L/PE)	47.07
106-011	58-2405	Piston Valve - PowrTwin 3500 & 4500, Scout	123.78
106-014	0-1679	O-Ring	2.60
106-015	15-1681	Teflon O-Ring	8.38
106-050	20-1685	Kit - PowrTwin JR, Scout, Super Scout (L/PE)	88.15
106-051	—	Replaced by 106-050 (20-1685)	—
106-116	44-1683	Sleeve, Spring	10.96
107-029	57-2270	Rod - PowrTwin 3500/4500	217.87
107-051	20-1857	Kit - PowrTwin 3500/4500 (L/PE)	86.46
107-060	8-2745	Gasket, Seat	5.10
107-501	—	Order (1) each: 107-029, 107-936, 107-051	—
107-936	57-2343	Cylinder - PowrTwin 3500/4500	—
107-946	—	Order as: 107-936 (57-2343)	—
108-940	—	Use: 107-936 Cylinder (4500)	—
138-019	8-1210	Gasket	19.68
138-025	—	Replaced by 138-225 (9-1183)	—
138-031	8-567	Nylon Gasket	2.25
138-052	20-570	Packing Set - Upper (L/PE)	55.38
138-053	20-1213	Packing Set - Upper (L/T)	55.38
138-054	20-1858	Packing Set - Upper (T/PE)	—
138-153	20-571	Packing Set - Lower (L/PE)	55.38
138-154	20-1214	Packing Set - Lower (L/T)	55.38
138-225	9-1183	SS Ball	3.18
138-252	20-1851	Packing Set - Upper (L/T)	55.38
138-253	20-1852	Packing Set - Lower (L/T)	55.38
138-256	—	Replaced by 138-053 (20-1213)	—
138-257	—	Replaced by 138-154 (20-1214)	—
138-258	—	Replaced by 138-052 (20-570)	—
138-259	—	Replaced by 138-153 (20-571)	—
138-340	9-534	Ball	6.36
138-520	20-1869	Packing Set - Upper (T)	55.38
138-521	—	Replaced by 138-520 (20-1869)	—
138-522	20-1870	Packing Set - Lower (T)	55.38
138-523	20-1859	Packing Set - Lower (T/PE)	55.38
138-917	57-2180	Rod - PowrTwin Classic, Atlas 30, Cmdr 60	213.60
138-941	—	Replaced by 143-945 (58-2327)	—
140-009	0-565	Foot Valve O-Ring	1.59
140-051	20-572	Kit - PowrTwin, Commander 60 (L/PE)	111.89
140-052	20-1215	Kit - PowrTwin, Commander 60 (L/T)	111.89
140-053	20-1871	Kit - PowrTwin, Commander 60 (T)	127.07
141-007	0-2441	O-Ring	1.23
143-019	10-1849	Retaining Ring	10.10
143-025	15-2699	Intake Seat O-Ring (XLT)	1.92
143-050	20-1853	Kit - PowrTwin 5500 (L/PE)	118.40
143-117	57-2274	Rod - PowrTwin 5500	269.29
143-127	—	Order as: Speeflo 143-117 (57-2274)	—

TITAN / SPEEFLO LIST PRICES ARE BASED ON SINGLE UNIT PRICE IN TITAN / SPEEFLO U.S. PRICE LIST DATED 21/09

BEDFORD® Replacement Parts For . . . TITAN / SPEEFLO Equipment

To order, contact your local
Paint Spray Equipment Dealer and ask for
Genuine Bedford Replacement Parts.

REPLACES TITAN PART NO.	BEDFORD PART NO.	DESCRIPTION	TITAN LIST PRICE (\$)
143-500	—	Order (1) each: 143-050, 143-117, 143-822	—
143-822	57-2329	Cylinder - PowrTwin 5500	337.92
143-945	58-2327	Piston Valve - PowrTwin, PT5500, Cmdr 60	111.89
144-050	20-2152	Kit - PowrTwin 8900GH, 10000, 12000GH	118.40
144-117	57-2594	Rod - PowrTwin 8900GH / 10000 / 12000GH	337.92
144-822	57-2587	Cylinder - PT 8900GH / 10000 / 12000GH	—
145-031	15-1473	Teflon O-Ring	13.41
145-051	20-1471	Kit - PowrTwin Classic, Atlas, Ensign (L/PE)	151.42
145-052	20-1472	Kit - PowrTwin Classic, Atlas, Ensign (L/T)	151.42
145-054	—	Replaced by 145-052 (20-1472)	—
145-055	—	Replaced by 145-051 (20-1471)	—
145-060	—	Replaced by 145-051 (20-1471)	—
145-061	—	Replaced by 145-052 (20-1472)	—
145-500	—	Order (1) ea: 145-051, 145-922, 138-917	—
145-501	—	Order (1) ea: 145-052, 145-922, 138-917	—
145-502	—	Order (1) ea: 148-050, 145-922, 138-917	—
145-922	57-2345	Cylinder - PT Classic, Atlas 30, Ensign 12	344.15
148-050	20-1854	Kit - 148 Series Pumps (L/T)	177.44
148-051	20-1860	Kit - 148 Series Pumps (T/PE)	177.44
160-124	—	Order as: (24) pcs 160-100 (14-516)	—
160-524	—	Order as: (24) pcs 160-500 (14-517)	—
173-133	15-1187	Teflon O-Ring	16.52
174-001	15-562	Teflon O-Ring	12.39
174-025	20-1698	Packing Set - Lower (L/T)	65.00
174-050	20-573	Kit - Ranger 3:1 (L/T)	146.32
174-051	20-865	Kit - Ranger 3:1 (L/T)	141.96
174-052	20-1692	Kit - Ranger 3:1, Trident 3:1, 174-554 Pmp (T)	156.07
174-055	20-1699	Kit - Ranger 3:1 (L/T/SS)	—
174-056	20-1701	Kit - Trident 3:1, 174-554 Pump (L/T)	154.48
174-058	20-1206	Kit - Ranger 3:1, Trident 3:1, 174-554 Pmp (T)	190.87
174-059	—	Replaced by 174-058 (20-1206)	—
175-001	20-574	V-Packing Set - Upper (L/T)	76.94
175-002	20-589	Cup Packing Set - Lower (L/T)	38.15
175-121	—	Replaced by 178-320 (20-1203)	—
175-220	—	Replaced by 178-320 (20-1203)	—
175-222	20-1204	Cup Packing Set - Lower (T)	—
178-001	20-1270	Packing Set - Upper (L/PE)	100.81
178-007	—	Replaced by 178-700 (9-477)	—
178-320	20-1203	Packing Set - Upper (T/SS)	55.06
178-420	20-1702	Packing Set - Upper (L/T)	76.94
178-700	9-477	Ball	23.55
180-002	20-576	Packing Set - Lower (L/T)	78.29
180-122	—	Replaced by 180-322 (20-1690)	—
180-124	—	Replaced by 180-322 (20-1690)	—
180-322	20-1690	Packing Set - Lower (T)	70.22
182-007	15-561	Teflon O-Ring	14.07
182-050	20-579	Pump Service Kit Minor (L/T)	175.13
182-921	58-2605	Piston Valve - HydraPro III/IV, Cmdr, Admrl	154.51
183-001	20-1279	Packing Set - Lower (L/PE)	121.64
183-050	—	Replaced by 185-051 (20-1319)	—
183-051	—	Replaced by 185-050 (20-1318)	—
183-052	—	Replaced by 185-052 (20-1691)	—
183-053	—	Replaced by 185-050 (20-1318)	—
183-230	0-880	O-Ring	2.90
183-930	57-2341	Cylinder - HydraPro IV/Super, Cmdr 30, Boss	507.45

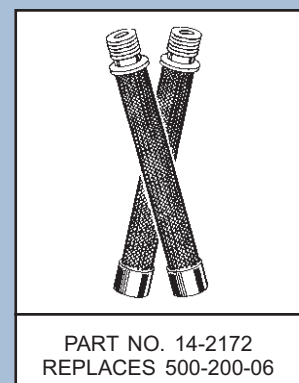
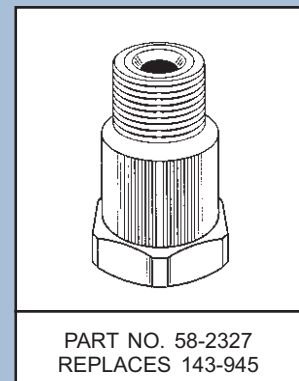
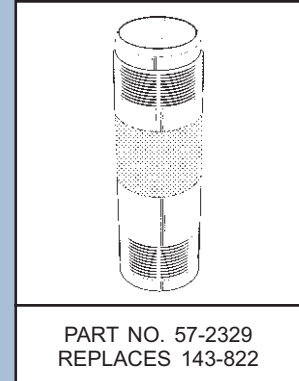

TITAN / SPEEFLO LIST PRICES ARE BASED ON SINGLE UNIT PRICE IN TITAN / SPEEFLO U.S. PRICE LIST DATED 21/09

To order, contact your local
Paint Spray Equipment Dealer and ask for
Genuine Bedford Replacement Parts.

BEDFORD® Replacement Parts For . . . TITAN / SPEEFLO Equipment

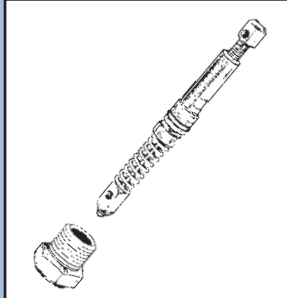

PART NO. 20-2088
REPLACES 520-025



PART NO. 20-2095
REPLACES 580-034

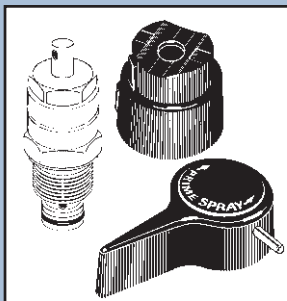

PART NO. 29-2600
REPLACES 700-258

REPLACES TITAN PART NO.	BEDFORD PART NO.	DESCRIPTION	TITAN LIST PRICE (\$)
185-050	20-1318	Kit - HydraPro III/IV/Super, Admrl, Boss (L/PE)	135.62
185-051	20-1319	Kit - HydraPro III/IV/Super, Admrl, Boss (L/T)	135.62
185-052	20-1691	Kit - HydraPro III/IV/Super, Admrl, Boss (T)	135.62
185-984	57-2272	Rod - HydraPro IV/Super, Admrl, Boss, Cmdr	394.43
200-551	12-403	Swivel Adapter 1/4" NPT(m) x 3/8" NPS(f)	—
200-555	12-465	Swivel Adapter 1/2" NPT(m) x 1/2" NPS(f)	—
201-520	20-2681	Kit - XLT Intake O-Ring & Outlet Washer	13.45
201-525	20-2746	O-Ring & Gasket, Seats	17.52
203-316	13-792	3' x 3/16" Airless Hose Assembly	52.50
211-029	—	Replaced by 211-129 (9-1697)	—
211-129	9-1697	Ball	21.23
221-008	0-2103	O-Ring	1.12
221-011	0-2104	O-Ring	—
221-012	0-2105	O-Ring	1.25
222-012	6-2106	Backup Ring	1.08
226-001	19-2089	Locknut, LX-80	1.57
227-027	12-2138	Plug, Manifold	1.23
227-100	28-759	Gauge, 1/4" NPT Btm Mnt, 0-100 PSI, 2"	29.09
234-702	0-1193	O-Ring	1.09
235-026	0-2442	O-Ring	3.07
235-027	16-2436	Piston Seal	15.14
235-028	16-2438	Rod Seal	18.05
235-050	20-2439	Hydraulic Motor Kit - PTwin 3500/4500/5500	45.00
236-011	8-2698	Piston Seat Washer (XLT)	—
240-001	20-2390	Packing Set - Hydra M 4000 (Ctr)	96.68
245-050	20-2396	Kit - Hydra M 4000 (Ctr)	224.90
248-979	—	Order as: 240-921 (57-2531)	—
314-180	9-876	Ball	54.11
325-005	23-2446	Trip Spring	3.52
420-065	—	Order as: (1) 420-070 (13-2558)	—
420-070	13-2558	1" x 5' Fluid Hose, Cut Length, No Fittings	59.05
425-029	—	Replaced by 858-812 (19-1217)	—
426-016	0-1196	O-Ring	11.26
426-051	22-864	Sealant	8.27
431-032	0-2443	O-Ring	3.99
432-628	—	Replaced by 872-005 (8-1657)	—
441-152	0-2444	O-Ring	3.68
441-217	0-2445	O-Ring	1.99
500-200-03	14-2171	Gun Filter (2 pcs), 30 Mesh, Coarse, Green	12.54
500-200-06	14-2172	Gun Filter (2 pcs), 60 Mesh, Medium, White	12.54
500-200-10	14-2173	Gun Filter (2 pcs), 100 Mesh, Fine, Yellow	12.54
500-200-15	14-2174	Gun Filter (2 pcs), 150 Mesh, Extra-Fine, Red	12.54
520-018	—	Replaced by 520-093 (58-2620)	—
520-020	10-2083	Washer	1.64
520-023	58-2087	Seal Assembly	55.15
520-025	20-2088	Kit - SGX-20 Gun	83.48
520-048	58-2086	Diffuser - SGX-20 Gun	34.75
520-093	—	Replaced by 520-099 (58-2620)	—
520-099	58-2620	Diffuser - LX-80	—
540-030	14-2161	Gun Filter, 30 Mesh, Green	5.76
540-060	14-2162	Gun Filter, 60 Mesh, White	5.76
540-100	14-2163	Gun Filter, 100 Mesh, Yellow	5.76
540-150	14-2164	Gun Filter, 150 Mesh, Red	5.76
541-025	3-559	Leather Cup Packing	—
541-026	17-618	Washer	—

TITAN / SPEEFLO LIST PRICES ARE BASED ON SINGLE UNIT PRICE IN TITAN / SPEEFLO U.S. PRICE LIST DATED 21/09

BEDFORD® Replacement Parts For . . . TITAN / SPEEFLO Equipment

To order, contact your local
Paint Spray Equipment Dealer and ask for
Genuine Bedford Replacement Parts.

REPLACES TITAN PART NO.	BEDFORD PART NO.	DESCRIPTION	TITAN LIST PRICE (\$)
541-125	4-560	Teflon Cup Packing	—
541-126	8-1198	Washer	—
558-015	—	Replaced by 872-005 (8-1657)	—
568-051	20-852	Packing Set - Upper (L/T)	64.46
568-052	20-585	Packing Set - Lower (L/T)	68.77
568-521	20-586	Packing Set - Upper (T)	74.75
568-522	20-587	Packing Set - Lower (T)	83.65
569-016	9-652	Ball	3.52
569-017	9-653	Ball	—
569-021	9-654	Ball	3.22
569-023	10-851	Gasket	6.11
569-120	8-598	Gasket	7.19
580-017	—	Replaced by 580-510 (58-2094)	—
580-034	20-2095	Kit - LX-80 & LX-80II Guns	72.74
580-510	58-2094	Needle Seal Assembly - LX-80 Gun	56.48
694-003	0-564	O-Ring	1.99
694-051	20-853	Kit - Ensign 35:1 (L/T)	127.00
700-024	0-2275	O-Ring	10.33
700-072	49-2190	Upper Seal - 440e, 447ex, 660ex, 690gx	22.42
700-201	0-2107	O-Ring	3.39
700-203	22-2206	Grease	3.12
700-240	—	Replaced by 700-258 (29-2600)	—
700-248	12-2617	Retainer, Drain Valve	3.34
700-250	58-2608	Stem Assembly, Drain Valve	18.25
700-252	47-2610	Cam Base, Drain Valve	18.00
700-258	29-2600	Bypass Valve Assembly	72.33
700-499	0-2108	O-Ring	1.79
700-537	10-2109	Bypass Gasket	1.25
700-580	57-2264	Rod - Epic 440e, 447ex, 660ex, 690gx	87.10
700-583	58-2100	Inlet Valve - 440e, 447ex, 660ex, 690gx	40.10
700-585	58-2102	Outlet Valve - 440e, 447ex, 660ex, 690gx	24.06
700-587	8-2207	Upper Guide	4.80
700-601	49-2187	Seal - 440e, 447ex, 660ex, 690gx, 440HP	25.28
700-603	—	Replaced by 700-072 (49-2190)	—
700-608	58-2134	Foot Valve Assy - 440e, 447ex, 660ex, 690gx	80.95
700-697	46-2619	Valve Handle, Drain Valve	9.45
700-721	0-2111	O-Ring	1.08
700-759	19-2618	Dowel Pin, Drain Valve	2.26
700-790	—	Replaced by 702-130 (20-2208)	—
700-793	21-2203	Piston Guide Tool	1.64
700-804	8-2110	Gasket	1.08
700-805	14-2081	Inlet Screen - 440e, 447ex, 660ex, 690gx	10.23
700-815	—	Replaced by 702-140 (20-2209)	—
700-821	8-2135	Foot Valve Seal	3.16
700-881	8-2136	Gasket	2.52
700-897	15-2137	Teflon O-Ring	4.53
701-031	7-888	Air Valve Packing	—
702-130	20-2208	Packing Kit - 440e, 447ex, 660ex, 690gx	51.66
702-140	20-2209	Rebuild Kit - 440e, 447ex, 660ex, 690gx	90.54
702-303	15-2528	Teflon O-Ring	3.35
704-089	—	Replaced by 704-560 (57-2720)	—
704-090	—	Replaced by 704-560 (57-2720)	—
704-113	20-2397	Kit - Epic 300HP	39.39
704-121	0-2448	O-Ring	2.00
704-289	44-2738	Bushing, Piston Guide	22.24

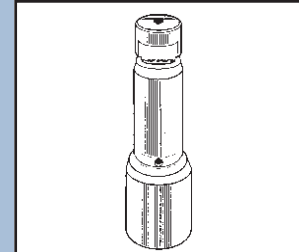

PART NO. 57-2264
REPLACES 700-580

PART NO. 57-2720
REPLACES 704-560

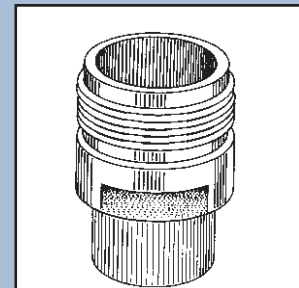

PART NO. 58-2134
REPLACES 700-608

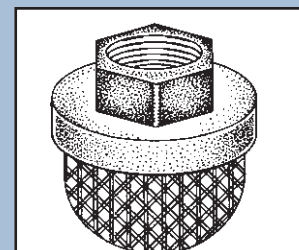

PART NO. 14-2081
REPLACES 700-805 3/4"

PART NO. 14-2082
REPLACES 710-046 1-5/16"

TITAN / SPEEFLO LIST PRICES ARE BASED ON SINGLE UNIT PRICE IN TITAN / SPEEFLO U.S. PRICE LIST DATED 21/09

To order, contact your local
Paint Spray Equipment Dealer and ask for
Genuine Bedford Replacement Parts.

BEDFORD® Replacement Parts For . . . TITAN / SPEEFLO Equipment



PART NO. 20-2209
REPLACES 702-140

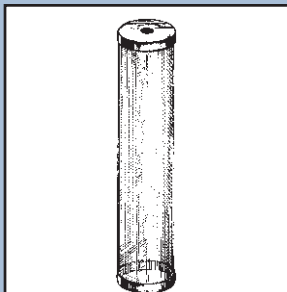

PART NO. 14-2097
REPLACES 730-067

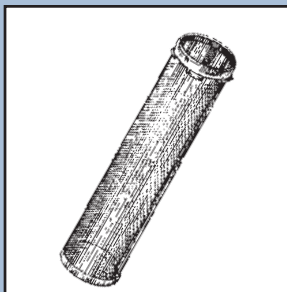

PART NO. 14-2101
REPLACES 761-043

REPLACES TITAN PART NO.	BEDFORD PART NO.	DESCRIPTION	TITAN LIST PRICE (\$)
704-547	49-2728	Lower Packing	33.91
704-551	57-2700	Rod - Epic Pumps	87.10
704-557	46-2692	Ball Cage, Outlet Valve	4.29
704-558	58-2691	Outlet Valve Seat	23.17
704-560	57-2720	Piston Rod Assembly - Epic Pumps	124.32
704-564	49-2729	Upper Packing Assembly & Tool	22.42
704-586	20-2727	Kit - 440ix, 640ix, 660ix	61.03
704-587	12-2693	Retainer, Outlet Valve Seat	16.95
710-046	14-2082	Inlet Screen - E15, E20, G40, G55, PM5500	14.41
710-069	—	Replaced by 227-027 (12-2138)	—
710-196	0-2139	O-Ring	—
711-605	8-2148	Tip Gasket, 1/16"	1.12
711-606	20-2149	Tip Gasket, 1/16" (12 pcs)	4.40
711-611	8-2156	Tip Gasket, 1/8"	.32
711-612	20-2157	Tip Gasket, 1/8" (12 pcs)	9.95
730-067	14-2097	Outlet Filter, 60M - 660ex, 690gx, Pro 690	5.64
730-067-10	14-2098	Outlet Filter, 100M - 660ex, 690gx, Pro 690	5.64
730-067-30	14-2096	Outlet Filter, 30M - 660ex, 690gx, Pro 690	5.64
730-401	20-2242	Kit - 440HP, 447HP, 660HPx	53.43
730-506	—	Replaced by 704-560 (57-2720)	—
730-509	—	Replaced by 704-289 (44-2738)	—
738-004	10-1207	Gasket	11.98
738-021	0-1192	O-Ring	1.37
738-213	23-1197	Trip Spring	9.51
738-224	0-1216	O-Ring	16.16
742-001	0-1195	O-Ring	1.37
742-051	20-1218	Air Motor Kit - Cmdr 30/60, PowrMastic	92.06
742-223	0-563	Valve Sleeve O-Ring	2.44
753-024	22-539	Teflon Sealant Tape	—
761-043	14-2101	Outlet Filter, 60 Mesh - E15, E20, G40, G55	9.39
761-057	15-2112	Teflon O-Ring	3.24
761-058	15-2113	Teflon O-Ring	4.53
761-072	49-2342	Upper Packing with Installation Tool	32.71
761-076	8-2140	Lower Seal	5.34
761-079	20-2115	Upper Seat & O-Ring - E20, G55, PM5500	53.28
761-080	20-2117	Lower Seat & O-Ring - E20, G55, PM5500	71.23
761-103	15-2118	Teflon O-Ring	4.40
761-111	8-2141	Upper Seal	3.28
761-136	—	Replaced by 761-072 (49-2342)	—
761-138	49-2196	Lower Seal - E20, G55, Promark 5500	29.30
761-144	9-2119	Ball, Upper	1.86
761-145	9-2120	Ball, Lower	6.42
761-175	20-2210	Kit - E20, G55, Promark 5500	101.21
761-247	23-2142	Core, Filter Manifold	29.93
761-273	21-2204	Piston Guide Tool	6.14
761-456	15-2121	Teflon O-Ring	6.16
762-057	15-2122	Teflon O-Ring	3.08
762-058	15-2123	Teflon O-Ring	4.19
762-072	49-2338	Upper Packing with Installation Tool	34.14
762-076	8-2143	Lower Seal	5.53
762-079	20-2125	Upper Seat & O-Ring - E15, G40	50.37
762-080	20-2127	Lower Seat & O-Ring - E15, G40	47.53
762-103	15-2128	Teflon O-Ring	4.18
762-111	8-2144	Upper Seal	3.10
762-134	58-2435	Upper Valve Seat	23.17

TITAN / SPEEFLO LIST PRICES ARE BASED ON SINGLE UNIT PRICE IN TITAN / SPEEFLO U.S. PRICE LIST DATED 21/09

BEDFORD® Replacement Parts For . . . TITAN / SPEEFLO Equipment

To order, contact your local
Paint Spray Equipment Dealer and ask for
Genuine Bedford Replacement Parts.

REPLACES TITAN PART NO.	BEDFORD PART NO.	DESCRIPTION	TITAN LIST PRICE (\$)
762-136	—	Replaced by 762-072 (49-2338)	—
762-137	58-2437	Intake Valve Seat	28.88
762-138	49-2202	Lower Seal - E15, G40	42.87
762-144	9-2129	Ball, Upper	2.03
762-145	9-2130	Ball, Lower	9.44
762-175	20-2211	Kit - E15, G40	93.10
762-273	21-2205	Piston Guide Tool - E15, G40	5.98
770-389	20-2150	O-Ring Packing Kit - HVLP Guns	15.83
770-401	0-2145	O-Ring	6.47
770-402	0-2146	O-Ring	4.01
770-410	0-2147	O-Ring	4.68
800-906	15-2744	Teflon O-Ring	7.18
800-923	—	Order as: (1) 700-881 & (1) 761-057	—
801-054	8-655	Nylon Washer	1.23
850-004	10-1208	Gasket	23.38
850-016	0-1194	O-Ring	16.29
850-050	20-1219	Air Motor Kit - Admiral, Cmndr 40, Alaskan	112.66
858-811	19-2447	Locknut	2.60
858-812	19-1217	Nut	1.08
872-005	8-1657	Gasket	1.99
891-193	15-2589	Teflon O-Ring	3.68
891-403	15-2394	Teflon O-Ring	14.07
892-281	0-2382	O-Ring	3.07
892-323	15-2395	Teflon O-Ring	15.14
911-025	55-874	Needle Valve Packing Set	25.23
911-125	55-1220	Needle Valve Packing Set	7.35
911-225	6-873	Packing Ring	6.64
916-007	—	Replaced by 569-021 (9-654)	—
920-004	14-2265	Outlet Filter - 50 Mesh	19.97
920-005	14-2266	Outlet Filter - 100 Mesh	19.97
920-006	6-2063	Gasket, Outlet Filter (Thick)	8.21
920-050	20-2449	Filter Service Kit - 920 Series Filter	29.37
920-070	6-2064	Gasket, Outlet Filter (Thin)	7.74
920-103	9-479	Ball	12.60
920-113	—	Replaced by 920-103 (9-479)	—
930-005	14-2344	Outlet Filter Element with Ball - 5 Mesh	29.37
930-006	14-2346	Outlet Filter Element with Ball - 50 Mesh	29.37
930-007	14-2347	Outlet Filter Element with Ball - 100 Mesh	29.37
930-020	23-2588	Spring	4.45
930-050	20-2586	Service Kit - 930 Series Outlet Manifold Filter	29.37
944-004	15-2522	Teflon O-Ring	3.07
944-023	44-2578	Stem, Dump Valve	—
944-026	44-2579	Stem Stop, Dump Valve	13.47
944-028	—	Replaced by 944-620 (29-2580)	—
944-050	20-2520	Valve Service Kit - 944-620 Bleed Valve	34.51
944-620	29-2580	Outlet Bleed Valve, 1/4" NPT(m) x 1/8" NPT(f)	157.25
944-904	58-2582	Valve Seat, 1/4" NPT(m)	69.90
945-003	10-2523	Gasket	2.44

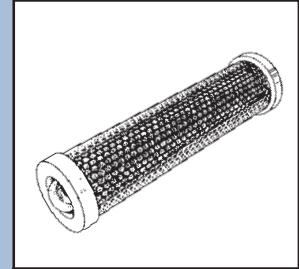

PART NO. 14-2344	5M
REPLACES 930-005	
PART NO. 14-2346	50M
REPLACES 930-006	
PART NO. 14-2347	100M
REPLACES 930-007	



PART NO. 29-2580
REPLACES 944-620

TITAN / SPEEFLO LIST PRICES ARE BASED ON SINGLE UNIT PRICE IN TITAN / SPEEFLO U.S. PRICE LIST DATED 2/1/09

To order, contact your local
Paint Spray Equipment Dealer and ask for
Genuine Bedford Replacement Parts.

BEDFORD® Replacement Parts For . . . KREMLIN Equipment

Replacement Parts for . . . KREMLIN

REPLACES KREMLIN PART NO.	BEDFORD PART NO.	DESCRIPTION	KREMLIN LIST PRICE (\$)
102-201-914	55-2505	Retaining Rings (10-pack)	22.50
102-202-101	55-2506	Retaining Rings (10-pack)	4.90
129-029-903	55-2507	Seals (10-pack)	28.50
129-529-903	55-2518	Teflon O-Rings (10-pack)	31.00
129-529-918	55-2509	Teflon O-Rings (10-pack)	50.50
129-609-902	55-2510	Seals (10-pack)	86.00
129-629-914	55-2512	Teflon O-Rings (10-pack)	44.50
129-659-901	20-2504	Gun Repair Kit - MX & MRX Spray Guns	38.50
129-739-910	55-2514	Valve Heads (10-pack)	31.00
129-971-002	55-2515	O-Rings (10-pack)	15.00
144-579-923	55-2516	O-Rings (10-pack)	27.00
144-850-150	20-2491	Repair Kit - 350 Air Motor	61.00
150-040-309	55-2517	Teflon O-Rings (10-pack)	27.50
668-300-035	55-2519	Teflon O-Rings (100-pack) Ref 129.529.903	—
668-300-043	55-2511	Teflon O-Rings (100-pack) Ref 129.629.914	—
668-300-044	55-2513	Valves Heads (5 x 10-pack) Ref 129.739.910	—

KREMLIN LIST PRICES ARE BASED ON SINGLE UNIT PRICE IN KREMLIN U.S. PRICE LIST DATED 1/1/09

To order, contact your local
Paint Spray Equipment Dealer and ask for
Genuine Bedford Replacement Parts.

BEDFORD® Replacement Parts For . . . LARIUS Equipment

Replacement Parts for . . . LARIUS

REPLACES LARIUS PART NO.	BEDFORD PART NO.	DESCRIPTION	LARIUS LIST PRICE (\$)
11003	8-812	Tip Sealing Washer	—
11016	10-772	Washer	—
11017	23-771	Spring	—
11019	14-834	Gun Filter, 180 Mesh, Red	—
11020	8-808	Washer	—
11037	14-833	Gun Filter, 100 Mesh, Yellow	—
11038	14-832	Gun Filter, 50 Mesh, White	—
11202	58-1495	Diffuser	—
11203	—	Replaced by Wagner 149700 (58-2305)	—
11204	58-1493	Ball Holder	—
11205	—	Replaced by Wagner 149700 (58-2305)	—
11205A	2-594	Teflon Seal	—
11209	19-1598	Locknut	—
95011-X1	1-2002	Leather V-Packing	—



BEDFORD® Replacement Parts

For . . . WAGNER & AMSPRAY Equipment

To order, contact your local
Paint Spray Equipment Dealer and ask for
Genuine Bedford Replacement Parts.

Quick Reference for . . . AMSPRAY Pumps

PUMP MODEL NAME	For the Bedford Replacement Part, refer to the following Amspray component P/N's				
	REPAIR KIT	ROD	CYLINDER / SLEEVE	PISTON VALVE	INTAKE VALVE
AMSPRAY					
AVENGER (396 FLUID SECT'S)	4235	181 or 191	299 (CYL)	186	205
AVENGER (EXCEL / 296 PUMPS)	4235	181 or 191	289 (SLV)	186	13363
AVENGER (PLANOTRONIC)	13292	—	—	—	310
BLACKBIRD	4239	—	—	—	—
BLUE MAX	4235	181 or 191	299(C) / 289(S)	186	205 or 13363
CORSAIR (396 FLUID SECT'S)	4235	181 or 191	299 (CYL)	186	205
CORSAIR (EXCEL / 296 PUMPS)	4235	181 or 191	289 (SLV)	186	13363
CORSAIR (PLANOTRONIC)	13292	—	—	—	310
FORMULA I S.E.	4239	—	—	—	—
MARAUDER	4239	—	—	—	—
MODEL 4	4235	181 or 191	299(C) / 289(S)	186	205 or 13363
MODEL 6	4235	181 or 191	299(C) / 289(S)	186	205 or 13363
MODEL 800	4239	—	—	—	—
PANTHER	4239	—	—	—	—
RC 125	13200	—	—	—	—
SPC 3000 G.E.	4235	181 or 191	299(C) / 289(S)	186	205 or 13363
TIGER	4239	—	—	—	—
FULLER O'BRIEN					
CHIEF	4235	181 or 191	299(C) / 289(S)	186	205 or 13363
MODEL 800	4239	—	—	—	—
SUPER CHIEF	4239	—	—	—	—
WARRIOR	4235	181 or 191	299(C) / 289(S)	186	205 or 13363
GLIDDEN					
500	4235	181 or 191	299(C) / 289(S)	186	205 or 13363
750	4235	19206	—	186	205 or 13363
FORMULA I	4239	—	—	—	—
SPRINT	4235	181 or 191	299(C) / 289(S)	186	205 or 13363
M.A.B.					
CHEETAH	4235	181 or 191	299(C) / 289(S)	186	205 or 13363
COUGAR	4235	181 or 191	299(C) / 289(S)	186	205 or 13363
PANTHER	4239	—	—	—	—
TIGER	4239	—	—	—	—
SINCLAIR					
SPC 2000	4235	181 or 191	299(C) / 289(S)	186	205 or 13363
SPC 3000	4235	181 or 191	299(C) / 289(S)	186	205 or 13363
SPC 8000	4239	—	—	—	—

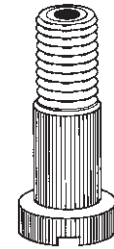

PART NO. 58-1737
REPLACES 186

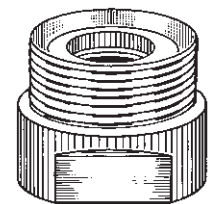

PART NO. 58-1709
REPLACES 205

To order, contact your local
Paint Spray Equipment Dealer and ask for
Genuine Bedford Replacement Parts.

BEDFORD® Replacement Parts For . . . WAGNER & AMSPRAY Equipment

Quick Reference for . . . WAGNER Piston Pumps

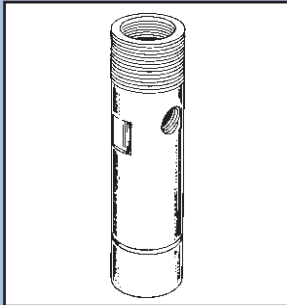

PART NO. 57-1431
REPLACES 299

PUMP MODEL	COMPONENT DESCRIPTIONS	REPLACES WAGNER PART NO.	BEDFORD PART NO.	NOTES
935	Repair Kit	295915	20-2652	Polyethylene
	Piston Rod	295306	57-2602	Stainless steel
945	Repair Kit	295915	20-2652	Polyethylene
	Piston Rod	295306	57-2602	Stainless steel
965	Piston Rod	295516	57-2604	Stainless steel
975	Repair Kit	279910	20-2263	Leather & polyethylene
EP 2005	Repair Kit	295989	20-2653	Polyethylene
	Piston Rod	295306	57-2602	Stainless steel
EP 2100	Repair Kit	294904	20-2065	Leather & polyethylene
EP 2105	Repair Kit	295900	20-2603	Polyethylene
	Piston Rod	295306	57-2602	Stainless steel
EP 2205	Piston Rod	295516	57-2604	Stainless steel
EP 2300	Repair Kit	294905	20-2066	Leather & polyethylene
EP 2400	Repair Kit	279910	20-2263	Leather & polyethylene
DSP 2500	Piston Rod	295516	57-2604	Stainless steel
Glidden 400 SE	Repair Kit	294904	20-2065	Leather & polyethylene
Glidden 500 SE	Repair Kit	294905	20-2066	Leather & polyethylene
Glidden 750 SE	Repair Kit	279910	20-2263	Leather & polyethylene
Glidden 1000 SE	Repair Kit	294920	20-2237	Leather & polyethylene
	Outlet Valve Seat	294516	58-2593	
Sinclair SPC-3900	Repair Kit	294905	20-2066	Leather & polyethylene

Quick Reference for . . . WAGNER Spray Guns

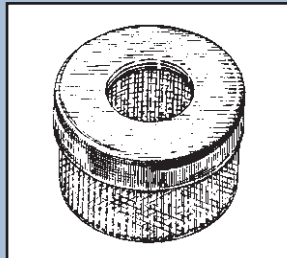

PART NO. 14-1325
REPLACES 2975 8M

PART NO. 14-1329
REPLACES 2976 16M

SPRAY GUN MODEL	REPLACES WAGNER PART NO.	BEDFORD PART NO.	DESCRIPTION
Wagner "G-10" SPRAY GUNS Models: G-9 / G-9N G-10 / G-10N Parts are also compatible with Amspray EZ-3000 & Larius AT-250 spray guns.	34377	14-832	Filter, Medium (White, 50 Mesh)
	34383	14-834	Filter, Extra-Fine (Red, 180 Mesh)
	43225	58-1495	Diffuser & Seat Assembly, "F" Thread (11/16")
	89323	14-831	Filter, Coarse (Green, 30 Mesh)
	89324	14-833	Filter, Fine (Yellow, 100 Mesh)
	149342	58-2016	Diffuser & Seat Assembly, "G" Thread (7/8")
	149700	58-2305	Needle/Ball Assembly
	270957	20-1751	Gun Repair Kit (Complete / Major) - includes: 11/16" Diffuser Assy, Needle/Ball Assy, Spring, X-Fine Filter, Med Filter, Locknut, (2) Swivel Washers, (2) Tip Washers, (2) Handle Washers
	279919	20-2160	Gun Repair Kit (Complete / Major) - includes: 7/8" Diffuser Assy, Needle/Ball Assy, Spring, Locknut, Swivel Washer, Tip Washer, Upper Handle Washer
	279625	20-2300	
347706	47-2450	Gun Handle Swivel Assembly & Washer	
Wagner XL SPRAY GUNS: G10XL / GH12XL	296261	58-2735	Diffuser & Seat Assembly, 7/8" thread
	296270	47-2736	Needle/Ball Assembly
	296294	20-2737	Gun Repair Kit (complete) - includes: 7/8" Diffuser, Needle/Ball Assy, Locknut,

BEDFORD® Replacement Parts

For . . . WAGNER & AMSPRAY Equipment

To order, contact your local
Paint Spray Equipment Dealer and ask for
Genuine Bedford Replacement Parts.

REPLACES WAGNER PART NO.	BEDFORD PART NO.	DESCRIPTION	WAGNER LIST PRICE (\$)
00043	18-1315	Female Adapter	—
00051	2-1357	Teflon V-Packing	—
00078	1-1633	Leather V-Packing	4.24
00086	18-1456	Male Adapter	5.31
00094	19-2655	Lower Packing Nut, Piston	8.36
00108	1-1634	Leather V-Packing	3.56
00116	—	Replaced by 08170 (49-1780)	—
00124	18-1538	Male Adapter	3.84
00132	18-1457	Female Gland	3.84
00159	—	Replaced by 186 (58-1737)	—
00181	57-1950	Rod - 296 & 396 Fluid Sections	135.90
00186	58-1737	Piston Valve - 296 & 396 Fluid Sections	73.29
00191	57-1391	Rod - 396 Fluid Section	—
00203	15-1779	Teflon O-Ring	3.33
00205	58-1709	Foot Valve Assembly - 396 Fluid Section	—
00215	15-1532	Teflon O-Ring	3.33
00248	10-1671	Gasket	2.94
00264	19-1513	Ball Stop Pin	—
00289	57-1901	Sleeve - 296 (Excel) Fluid Section	129.91
00299	57-1431	Cylinder - 396 Fluid Section	—
02975	14-1325	Inlet Strainer (Coarse), 3/4" NPT Thread	10.49
02976	14-1329	Inlet Strainer (Fine), 3/4" NPT Thread	16.90
04235	20-1783	Kit - 296, 396, 19308 Fluid Sections	55.60
04239	20-1784	Kit - 9000, 9024 Fluid Sections	68.49
04243	—	Replaced by 04235 (20-1783)	—
04245	—	Replaced by 04235 (20-1783)	—
04249	—	Replaced by 04239 (20-1784)	—
04339	14-1489	Strainer - 50 Mesh	14.30
04340	14-1490	Strainer - 100 Mesh	16.05
04341	15-1474	Teflon O-Ring	4.07
05568	20-1511	Kit - 296, 396, 19308 Fluid Sections (Teflon)	—
08070	49-1778	V-Packing	4.46
08080	49-1777	V-Packing	4.29
08170	49-1780	V-Packing	—
08180	49-1781	V-Packing	2.94
09075	18-1367	Female Adapter	—
09083	—	Replaced by 08070 (49-1778)	—
09091	1-1637	Leather V-Packing	7.46
09105	18-1368	Male Adapter	—
09120	—	Replaced by 4239 (20-1784)	—
09148	18-1369	Female Adapter	12.32
09156	—	Replaced by 08080 (49-1777)	—
09164	1-1639	Leather V-Packing	6.78
09172	18-1378	Male Adapter	—
09261	10-1379	Copper Gasket	5.31
09441	15-1536	Teflon O-Ring	3.84
09446	10-1882	Washer	1.24
10775	—	Replaced by 93638 (58-1700)	—
10778	8-807	Sealing Washer	—
10779	23-769	Outlet Valve Spring	—
10780	—	Replaced by 9970102 (10-768)	—
12386	9-1862	Ball	—
13055	19-1863	Retaining Ring	—
13057	49-1868	V-Packing	—
13090	1-1864	Leather V-Packing	—
13147	15-1850	Teflon O-Ring	—
13200	20-1861	Kit - RC125	—
13204	18-1865	Female Adapter	—
13206	18-1866	Male Adapter	—
13292	20-1886	Kit - "NEW" Avenger/Corsair, 91 Fluid Section	56.00

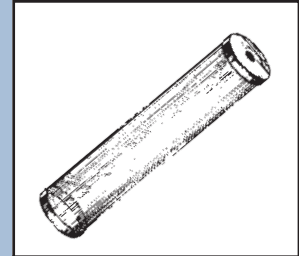

PART NO. 14-1489 50M
REPLACES 4339

PART NO. 14-1490 100M
REPLACES 4340

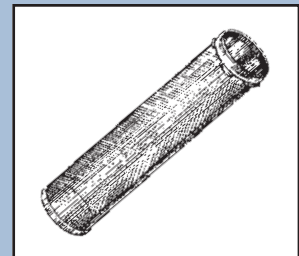

PART NO. 14-2595 50M
REPLACES 14069

PART NO. 14-2596 100M
REPLACES 14068

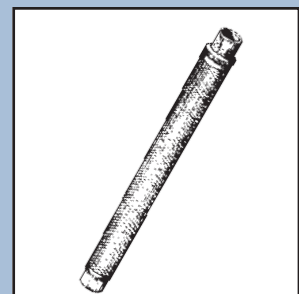

PART NO. 14-832
REPLACES 34377

WAGNER LIST PRICES ARE BASED ON SINGLE UNIT PRICE IN WAGNER U.S. PRICE LIST DATED 1/1/09

To order, contact your local
Paint Spray Equipment Dealer and ask for
Genuine Bedford Replacement Parts.

BEDFORD® Replacement Parts For . . . WAGNER & AMSPRAY Equipment

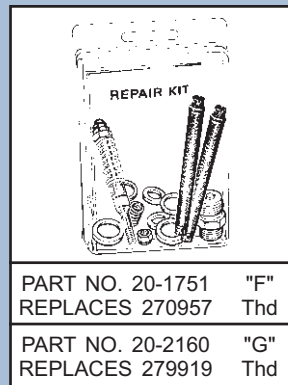
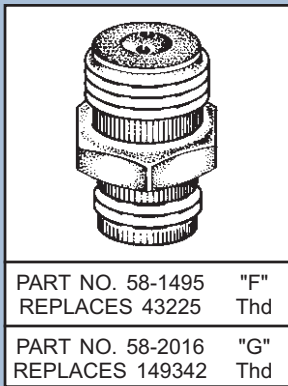
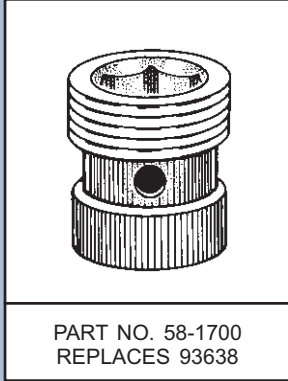

REPLACES WAGNER PART NO.	BEDFORD PART NO.	DESCRIPTION	WAGNER LIST PRICE (\$)
13361	18-1883	Female Gland	3.84
13364	19-1884	Wave Spring	7.46
13367	0-1535	O-Ring	3.33
13381	15-1885	Teflon O-Ring	3.67
13402	15-1782	Teflon O-Ring	—
13592	—	Replaced by 13292 (20-1886)	—
13597	—	Replaced by 203 (15-1779)	—
13862	—	Replaced by 04239 (20-1784)	—
14068	14-2596	Filter Element, Outlet Manifold, 100 Mesh	5.63
14069	14-2595	Filter Element, Outlet Manifold, 50 Mesh	5.63
14072	15-2243	Teflon O-Ring	4.13
16101	—	Discontinued - no longer in stock	—
19206	57-1514	Rod - "750" Pump	—
25014	15-1844	Teflon O-Ring	—
25029	6-1843	Backup Ring	—
34377	14-832	Gun Filter, 50 Mesh, Medium (White)	—
34383	14-834	Gun Filter, 180 Mesh, Extra-Fine (Red)	—
34511	—	Replaced by 9941501 (9-809)	—
34512	23-767	Spring	—
36462	8-588	Support, Spring	—
43052	8-812	Tip Sealing Washer	—
43209	—	Replaced by 9922703 (19-1447)	—
43211	2-594	Teflon Seal - G10 Gun	—
43215	58-1493	Ball Holder Assembly	—
43225	58-1495	Diffuser Assembly, 11/16" - G10 Gun	—
43230	—	Replaced by 149700 (58-2305)	—
43232	—	Replaced by 149700 (58-2305)	—
43234	—	Replaced by 89324 (14-833)	—
43260	10-772	Washer	—
43269	—	Replaced by 347706 (47-2450)	—
43303	8-808	Washer	—
43553	—	Replaced by 9910201 (19-1598)	—
43590	23-771	Spring	—
47485	23-1389	Spring, Outlet	—
47486	—	Replaced by 93635 (9-1049)	—
50164	9-1640	Ball	2.03
50172	9-1641	Ball	6.61
50849	19-1867	Cotter Pin	—
51055	12-1482	Plug, 1/4" NPT with Hex Socket End	—
51519	9-1642	Ball	11.64
51799	9-1643	Ball	3.22
51829	19-1644	Cotter Pin	1.24
51831	19-1316	Cotter Pin	1.24
51841	19-1377	Cotter Pin	1.24
55109	—	Replaced by 154014 (13-931)	—
55412	—	Replaced by 9970103 (10-770)	—
88005	12-403	Swivel Adapter 1/4" NPT(m) x 3/8" NPS(f)	—
88161	12-404	Swivel Adapter 3/8" NPT(m) x 1/4" NPS(f)	—
88162	12-229	Nipple 1/4" NPT x 3/8" NPT	—
88241	14-856	Filter, Low Line	—
88537	20-1567	Kit - G10 Overhaul	—
88600	13-798	5' x 3/16" Airless Hose Assembly	—
89323	14-831	Gun Filter, 30 Mesh, Coarse (Green)	—
89324	14-833	Gun Filter, 100 Mesh, Fine (Yellow)	—
89494	8-2158	Seal, Outlet Seat	—
89957	55-891	Gun Filter (Kit of 2), Green, 30 Mesh	—
89958	55-892	Gun Filter (Kit of 2), White, 50 Mesh	—
89959	55-893	Gun Filter (Kit of 2), Yellow, 100 Mesh	—
89960	55-894	Gun Filter (Kit of 2), Red, 180 Mesh	—
93635	9-1049	Carbide Ball 6MM (was 47486)	—

WAGNER LIST PRICES ARE BASED ON SINGLE UNIT PRICE IN WAGNER U.S. PRICE LIST DATED 1/1/09

BEDFORD® Replacement Parts For . . . WAGNER & AMSPRAY Equipment

To order, contact your local
Paint Spray Equipment Dealer and ask for
Genuine Bedford Replacement Parts.

REPLACES WAGNER PART NO.	BEDFORD PART NO.	DESCRIPTION	WAGNER LIST PRICE (\$)
93638	58-1700	Outlet Valve Seat (was 10775)	—
93654	0-1508	O-Ring	—
93896	12-228	Nipple 1/4" NPT x 1/4" NPT	—
0149342	58-2016	Diffuser Assembly, 7/8" - G10 to RAC IV Tip	36.79
0149700	58-2305	Needle Assembly - G10 Gun	36.79
0154014	13-931	25' x 1/4" Airless Hose Assembly (Blue)	—
0154015	13-932	50' x 1/4" Airless Hose Assembly (Blue)	—
0270491	9-2309	Ball, 5/16" Carbide	—
0270954	20-1787	Kit - Outlet Valve	66.73
0270957	20-1751	Kit - G10 Spray Gun, 11/16" Diffuser Thread	61.48
0275520	54-84	Seal, Thiokol	5.20
0276258	—	Order as: (6) pcs 275520 (54-84)	—
0279625	20-2300	Kit - G-10 Spray Gun, 7/8" Diffuser Thread	67.13
0279910	20-2263	Kit - 975, EP2400, 750SE	51.71
0279919	20-2160	Kit - G10 Spray Gun, 7/8" Diffuser Thread	61.48
0294301	23-2068	Retaining Ring	1.24
0294326	18-2067	Male Adapter	5.82
0294358	18-2169	Male Adapter	7.69
0294375	18-2069	Female Adapter, Lower	—
0294376	18-2070	Male Adapter, Upper	5.48
0294377	18-2071	Female Adapter, Upper	5.48
0294379	23-2072	Wave Spring, Upper	13.84
0294381	18-2073	Female Adapter, Lower	—
0294484	18-2074	Female Adapter, Lower	—
0294499	8-2592	Seal, Dump Valve	2.15
0294516	58-2593	Outlet Seat - EP 2510, EPX 2305/2405/2505	41.42
0294676	—	Replaced by 294905 (20-2066)	—
0294678	—	Replaced by 279910 (20-2263)	—
0294904	20-2065	Kit - 400SE, EP2100	49.50
0294905	20-2066	Kit - EP2300, SPC-3900, 500SE	46.06
0294914	—	Replaced by 294904 (20-2065)	—
0294920	20-2237	Kit - Glidden 1000SE	—
0294966	20-2590	Kit - Prime/Spray Valve	62.44
0295306	57-2602	Rod - EP2005, EP2105, 935, 945	84.65
0295307	46-2622	Outlet Ball Guide	4.29
0295308	18-2627	Upper Spacer	7.12
0295309	18-2623	Lower Spacer	11.30
0295310	49-2624	Upper Packing	14.18
0295311	49-2625	Lower Packing	21.19
0295362	18-2753	Lower Spacer	11.30
0295363	18-2754	Upper Spacer	7.12
0295366	15-2749	Teflon O-Ring	2.15
0295378	49-2751	T-Lip Packing, Upper	15.26
0295379	49-2752	T-Lip Packing, Lower	14.18
0295516	57-2604	Rod - EP2205, DSP2500, 965	89.90
0295900	20-2603	Kit - EP2105	49.50
0295904	20-2750	Repair Kit - EP2205	49.50
0295915	20-2652	Kit - 935, 945	—
0295989	20-2653	Kit - EP2005	49.50
0296261	58-2735	Diffuser - G10XL, G12XL	—
0296270	47-2736	Needle Assembly - G10XL, G12XL	45.15
0296294	20-2737	Kit - G10XL, G12XL	67.81
0347706	47-2450	Gun Swivel - G-10	39.39
0507928	57-2742	Rod - EPX2305	—
0508315	15-2626	Teflon O-Ring	.79
0508748	14-2747	Outlet Filter, 60 Mesh	5.37
0509762	14-2748	Inlet Strainer, for 1-1/4" Suction Tube	29.05
5006536	14-2682	Inlet Strainer, 1-5/16" Thread	13.72
9841502	9-2591	Ball, 10mm, Carbide	14.47
9871045	0-2565	O-Ring	.96

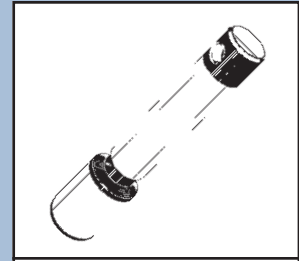

PART NO. 57-2602
REPLACES 295306

PART NO. 57-2604
REPLACES 295516

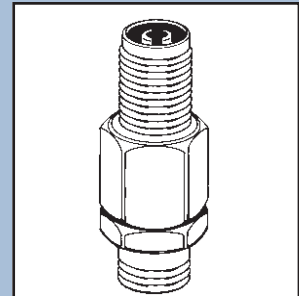

PART NO. 47-2450
REPLACES 347706

WAGNER LIST PRICES ARE BASED ON SINGLE UNIT PRICE IN WAGNER U.S. PRICE LIST DATED 1/1/09

To order, contact your local
Paint Spray Equipment Dealer and ask for
Genuine Bedford Replacement Parts.

BEDFORD® Replacement Parts For . . . WAGNER & AMSPRAY Equipment

Replacement Parts for . . . WAGNER (continued)

REPLACES WAGNER PART NO.	BEDFORD PART NO.	DESCRIPTION	WAGNER LIST PRICE (\$)
9871046	0-2577	O-Ring	1.19
9894231	23-2236	Wave Spring	12.26
9910201	19-1598	Nut	.23
9922703	19-1447	Retaining Ring (was 43209)	.40
9941501	9-809	Carbide Ball 11MM (was 34511)	19.38
9941504	—	Replaced by 93635 (9-1049)	—
9941518	9-2651	Ball, 11mm Stainless Steel	10.28
9970102	10-768	Sealing Washer (was 10780)	2.32
9970103	10-770	Washer (was 55412)	1.58

WAGNER LIST PRICES ARE BASED ON SINGLE UNIT PRICE IN WAGNER U.S. PRICE LIST DATED 1/1/09

To order, contact your local
Paint Spray Equipment Dealer and ask for
Genuine Bedford Replacement Parts.

BEDFORD® Replacement Parts For . . . SHERWIN-WILLIAMS Equipment

Quick Reference for . . . SHERWIN-WILLIAMS Pumps

PUMP MODEL	FOR THE FOLLOWING FLUID SECTIONS:	REFER TO GRACO PART NUMBERS (SEE PAGES 18-44)				
		REPAIR KIT	ROD	SLEEVE / CYLINDER	PISTON VALVE	INTAKE VALVE
NOVA	1-Piece Cylinder	222-587	181-879	177-929 (Cylinder)	218-197	215-455
	Sleeved Cylinder		183-563	183-571 (Sleeve)		221-098
NOVA SP / SPx	S/Ns beginning with "A"	235-703	187-613	236-786 (Cylinder)	224-808	224-966
	S/Ns beginning with "BA"		235-709	235-708 (Cylinder)	218-197	224-966
NOVA PRO	1-Piece Cylinder	244-194	—	—	243-181	243-190
SP	1-Piece Cylinder	243-091	—	235-708 (Cylinder)	218-197	224-996
SPX	1-Piece Cylinder	244-194	—	—	243-181	243-190
SUPER NOVA	1-Piece Cylinder	222-587	181-879	177-929 (Cylinder)	218-197	215-455
	Sleeved Cylinder		183-563	183-571 (Sleeve)	218-197	221-098
SUPER NOVA 700	1-Piece Cylinder	222-588	222-438	178-949 (Cylinder)	218-036	217-574
	Sleeved Cylinder		185-213 (Sleeve)	185-211 (Cylinder)		222-437
SUPER NOVA SP / SPx & PLUS	1-Piece Cylinder	235-703	235-709	235-708 (Cylinder)	218-197	224-966
ULTIMATE 500	1-Piece Cylinder	222-587	181-879	177-929 (Cylinder)	218-197	215-455
	Sleeved Cylinder		183-563	183-571 (Sleeve)		221-098
ULTIMATE 600	1-Piece Cylinder	235-703	235-709	235-708 (Cylinder)	218-197	224-966
ULTIMATE 1000	1-Piece Cylinder	222-588	222-438	178-949 (Cylinder)	218-036	217-574
	Sleeved Cylinder		185-213 (Sleeve)	185-211 (Cylinder)		222-437
ULTIMATE 1500	Sleeved Cylinder	220-877	220-630	183-361 (Sleeve) 183-181 (Cylinder)	220-631	220-629
ULTIMATE MX 695	1-Piece Cylinder	244-194	—	—	243-181	243-190
ULTIMATE MX 795	Sleeved Cylinder	248-212	240-518	240-521 (Sleeve)	239-932	239-922
ULTIMATE MX 1095	Sleeved Cylinder	248-212	240-518	240-521 (Sleeve)	239-932	239-922
ULTIMATE MX 1595	Sleeved Cylinder	248-213	240-515	240-525 (Sleeve)	240-150	244-199
ULTIMATE NOVA 395 / 495	1-Piece Cylinder	244-194	—	—	—	—

BEDFORD® Replacement Parts PAINT STRAINERS

To order, contact your local
Paint Spray Equipment Dealer and ask for
Genuine Bedford Replacement Parts.

- 60 Mesh fabric
- Specially woven for straining
- Resistant to paint solvents
- Stops spray gun clogging

2 Sizes...

SIZE	PACKED 12 / POLY BAG
	BEDFORD PART NO.
1 GALLON	14-516
5 GALLON	14-517

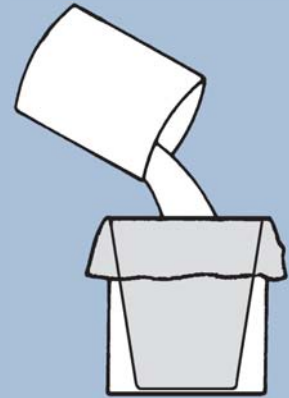



BEDFORD® Replacement Parts DISPOSABLE PROTECTIVE CLOTHING

To order, contact your local
Paint Spray Equipment Dealer and ask for
Genuine Bedford Replacement Parts.

	FABRIC STRETCH SOCK		
	ONE SIZE FITS ALL INDIVIDUALLY PACKED	SIZE	PART NO.
		ONE SIZE FITS ALL	41-1497

	TYVEK® HOODS		
	SNAP CLOSURE ONE SIZE FITS ALL PACKED 12 / POLY BAG	SIZE	PART NO.
		ONE SIZE FITS ALL	41-898

	TYVEK® SHIRTS		
	SNAP CLOSURE TWO SIZES INDIVIDUALLY PACKED	SIZE	PART NO.
		LARGE	41-1271
X-LARGE	41-1272		

	TYVEK® PANTS		
	ELASTIC WAIST TWO SIZES INDIVIDUALLY PACKED	SIZE	PART NO.
		LARGE	41-1273
X-LARGE	41-1274		

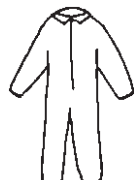
	TYVEK® COVERALLS		
	ZIPPER FRONT CLOSURE THREE SIZES INDIVIDUALLY PACKED	SIZE	PART NO.
		LARGE	41-901
X-LARGE		41-964	
XX-LARGE	41-928		

To order, contact your local
Paint Spray Equipment Dealer and ask for
Genuine Bedford Replacement Parts.

BEDFORD® Replacement Parts

TANK & CUP LID GASKETS

Manufactured from the highest quality Thiokol, Stratoprene, Rubber, Leather and Plastic compounds combining the best possible solvent resisting and elastic properties for maximum seal and long life. Thiokol gaskets provide maximum solvent resistance. More economical Stratoprene gaskets provide moderate solvent resistance and are excellent when used with water based materials.

TANK-LID GASKETS



O.E.M.	SIZE	REPLACES O.E.M. PART NO.	MATERIAL	BEDFORD PART NO.
BINKS	2 Gallon	83-1419-T	Thiokol	56-19
		83-1419	Stratoprene	56-90
	5 Gallon	83-1420	Stratoprene	56-91
	10, 15 Gallon	83-1421	Stratoprene	56-92
DEVILBISS	2-1/2 Gallon	PT-33-1	Stratoprene	56-97
	5, 15 Gallon	QM-1458-1	Stratoprene	56-98
	2 Gallon	QM-1462	Stratoprene	56-93
	2 Gallon	QMS-67	Stratoprene	56-94
	2-1/2 Gallon	QMS-80-1	Stratoprene	56-95
	2 Gallon	QN-96	Rubber	56-96

CUP-LID GASKETS



REPLACES		DESCRIPTION	BEDFORD PART NO.
O.E.M.	PART NO.		
BINKS	55-30	8 Ounce Siphon Cup, Leather	54-29
	56-730	Model 35 Gun, Thiokol	54-32
	80-11	1 & 2 Qt Pressure Cup, White Plastic	54-81
	80-45	1 & 2 Quart Pressure Cup, Leather	54-45
	82-56	1 Quart Siphon Cup, Thiokol	54-56
	82-56-F	1 Quart Siphon Cup, White Plastic	54-55
	82-467	1 Quart Siphon Cup, Leather	54-7
DEVILBISS	C-39-K5	White Plastic (5-pack)	55-71
	GC-25-K5	White Plastic (5-pack)	55-76
	KR-11-K5	White Plastic (5-pack)	55-74
	KR-69-K5	Leather (5-pack)	55-72
	TGC-9-K5	White Plastic (5-pack)	55-87
GRACO	M70628	2 Quart Cup, White Plastic	54-25
WAGNER	275520	Thiokol	54-84

BEDFORD® Replacement Parts

HIGH PRESSURE VALVES

To order, contact your local Paint Spray Equipment Dealer and ask for Genuine Bedford Replacement Parts.

HIGH PRESSURE BALL VALVES

5000 PSI MAXIMUM WORKING PRESSURE

REPLACES GRACO PART NO.	BEDFORD PART NO.	DESCRIPTION Inlet x Outlet (under handle)
210-657	29-1440	1/4" NPT(m) x 1/4" NPT(m) with Viton Seals
210-658	29-1441	3/8" NPT(m) x 3/8" NPT(m) with Viton Seals
210-659	29-1442	3/8" NPT(m) x 1/4" NPT(m) with Viton Seals
214-037	29-1443	1/4" NPT(m) x 1/4" NPT(m) with Teflon Seals
223-959	29-1791	3/8" NPT(m) x 1/4" NPT(m) with Teflon Seals
223-960	29-1504	3/8" NPT(m) x 3/8" NPT(m) with Teflon Seals
217-559	20-1259	Ball Valve Repair Kit - Viton Contains: Valve Ball, Seats & Viton Seals
217-560	20-1260	Ball Valve Repair Kit - Teflon Contains: Valve Ball, Seats & Teflon Seals

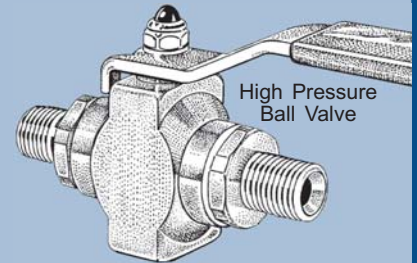

High Pressure Ball Valve

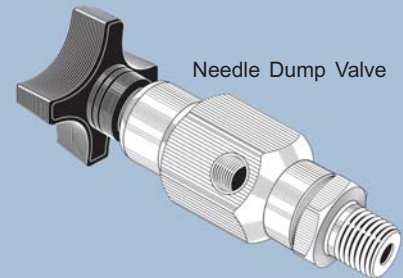

Needle Dump Valve

NEEDLE DUMP VALVE

5000 PSI MAXIMUM WORKING PRESSURE

REPLACES SPEEFLO PART NO.	BEDFORD PART NO.	DESCRIPTION
944-620	29-2580	1/4" NPT(m) Inlet x 1/8" NPT(f) Outlet

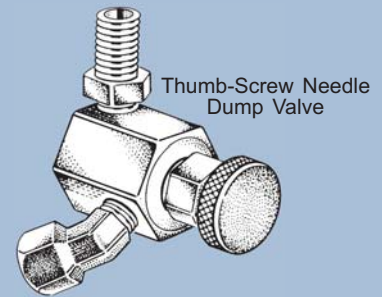

Thumb-Screw Needle Dump Valve

THUMB-SCREW NEEDLE DUMP VALVES

5000 PSI MAXIMUM WORKING PRESSURE

REPLACES GRACO PART NO.	BEDFORD PART NO.	DESCRIPTION
222-198	29-1974	1/4" NPT(m) Inlet Connection
224-775	29-2630	1/8" NPT(f) Inlet x 1/8" NPT(f) Outlet, Bare Valve
235-198	20-2078	Dump Valve Repair Kit - Contains: Stem Assembly, Ball, Carbide Seat, Gasket

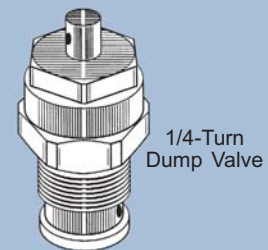

1/4-Turn Dump Valve

1/4-TURN DUMP VALVE

3000 PSI MAXIMUM WORKING PRESSURE

REPLACES GRACO PART NO.	BEDFORD PART NO.	DESCRIPTION
235-014	20-2324	Valve Body Assembly, Carbide Ball Seat, & Gasket

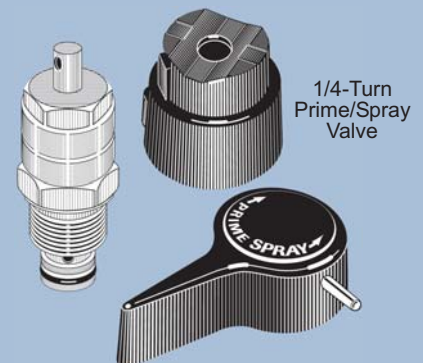

1/4-Turn Prime/Spray Valve

1/4-TURN PRIME/SPRAY VALVE

3000 PSI MAXIMUM WORKING PRESSURE

REPLACES TITAN PART NO.	BEDFORD PART NO.	DESCRIPTION
700-258	29-2600	Valve Body Assembly, Handle Base, Pin

To order, contact your local
Paint Spray Equipment Dealer and ask for
Genuine Bedford Replacement Parts.

BEDFORD® Replacement Parts LOW PRESSURE VALVES

LOW PRESSURE BALL VALVES

250 PSI MAXIMUM WORKING PRESSURE

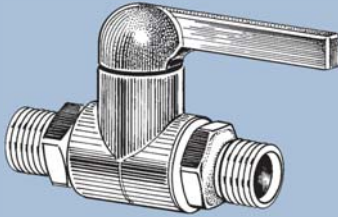

Low Pressure Ball Valve

REPLACES BINKS PART NO.	BEDFORD PART NO.	FITTING CONFIGURATION Outlet (under handle) x Inlet
72-81611	29-1570	1/4" NPS(m) x 1/4" NPT(m)
72-81712	29-1571	3/8" NPS(m) x 3/8" NPT(m)
72-81612	29-1672	1/4" NPS(m) x 3/8" NPT(m)
72-81216	29-1693	3/8" NPT(m) x 1/4" NPS(m)
72-81711	29-1694	3/8" NPS(m) x 1/4" NPT(m)
72-81212	29-2375	3/8" NPT(m) x 3/8" NPT(m)
72-83030	29-2575	1/4" NPT(m) x 1/4" NPT(m)
72-84030	29-2601	3/8" NPT(m) x 1/4" NPT(m)
72-84040	29-2576	3/8" NPT(m) x 3/8" NPT(m)
83-2600	6-982	Replacement Teflon Seal (2 required per valve)

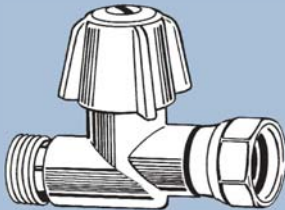

Air Metering "Cheater" Valve

AIR METERING "CHEATER" VALVE

125 PSI MAXIMUM WORKING PRESSURE

REPLACES BINKS PART NO.	BEDFORD PART NO.	DESCRIPTION
73-157	29-1680	1/4" NPS(m) x 1/4" NPS(f)

To order, contact your local
Paint Spray Equipment Dealer and ask for
Genuine Bedford Replacement Parts.

BEDFORD® Replacement Parts QUART SIPHON CUP ASSEMBLIES



Non-Drip Quart
Siphon Cup Assembly

BEDFORD Quart Siphon Cup Assembly comes complete with sturdy aluminum cup and 3/8" NPS female swivel nut connection that fits most guns.

Available in Standard and Non-Drip models with exclusive directional vent tube.

Individually boxed.

REPLACES BINKS PART NO.	BEDFORD PART NO.	DESCRIPTION
81-550	45-1255	Standard Unit (Complete Assembly)
81-350	45-1235	Non-Drip Unit (Complete Assembly)
82-47	45-899	Quart Cup (Fits both units)
82-467	54-7	Gasket, Leather (as supplied with units)
82-56	54-56	Gasket, Thiokol
82-56-F	54-55	Gasket, White Foam
—	13-250	Vent Tube Assembly

BEDFORD® Replacement Parts

LOW PRESSURE BULK HOSE

To order, contact your local
Paint Spray Equipment Dealer and ask for
Genuine Bedford Replacement Parts.

LOW PRESSURE BULK HOSE

AIR HOSE

- Red Cover
- Full Reels: 600'-750'
- Maximum Working Pressure: 250 PSI
- Maximum 3 Pieces per Reel (Random Lengths)

DIMENSIONS		NO. BRAIDS	TUBE	COVER	REPLACES PART NO.			BEDFORD FULL REEL	BEDFORD CUT LENGTH
I.D.	O.D.				BINKS	DEVILBISS	GRACO	PART NO.	PART NO.
1/4"	1/2"	1	Buna-N	Smooth	71-10000	H1957-1	061-204	13-4	13-64
5/16"	5/8"	1	Buna-N	Corrugated	—	H1901-1	—	13-57	13-77
5/16"	5/8"	1	Buna-N	Smooth	71-11000	H1921-1	061-207	13-59	13-79
3/8"	11/16"	1	Buna-N	Smooth	71-12000	H1958-1	061-089	13-6	13-66



FLUID HOSE

- Black Neoprene Cover
- Full Reels: 600'-750'
- Maximum Working Pressure: 750 PSI
- Nylon Inner Tube
- Maximum 3 Pieces per Reel (Random Lengths)
- Temperature Range: -40°F to +190°F

DIMENSIONS		NO. BRAIDS	TUBE	COVER	REPLACES PART NO.			BEDFORD FULL REEL	BEDFORD CUT LENGTH
I.D.	O.D.				BINKS	DEVILBISS	GRACO	PART NO.	PART NO.
1/4"	1/2"	1	Nylon	Neoprene	71-280	H1975-1	061-205	13-470	13-1170
3/8"	11/16"	1	Nylon	Neoprene	71-282	H1973-1	061-195	13-480	13-1180
1/2"	7/8"	2	Nylon	Neoprene	71-283	H1974-1	061-200	13-1010	13-1110
3/4"	1-3/16"	2	Nylon	Neoprene	71-284	—	061-185	13-490	13-1190
1"	1-1/2"	2	Nylon	Neoprene	71-285	—	061-188	13-2550	—

LOW PRESSURE REUSABLE HOSE CONNECTIONS

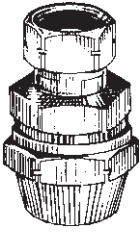
- Plated Brass
- 30° Seat

	BEDFORD PART NO.	REPLACEMENT FOR:			HOSE SIZE ID x OD	THREAD
		BINKS PART NO.	DEVILBISS PART NO.	GRACO PART NO.		
	12-304	72-1303	P-HC-4523	104-415	1/4" x 1/2"	1/4" NPS(F) Swivel
	12-306	72-1306	P-HC-4543	104-084	1/4" x 1/2"	3/8" NPS(F) Swivel
	12-301	72-1317	P-HC-4527	103-605	5/16" x 5/8"	1/4" NPS(F) Swivel
	12-305	72-1478	P-HC-4599	—	5/16" x 5/8"	1/4" NPT(M)
	12-302	72-1328	P-HC-4548	104-414	3/8" x 11/16"	3/8" NPS(F) Swivel
	12-303	72-1325	P-HC-4528	—	3/8" x 11/16"	1/4" NPS(F) Swivel
	12-368	72-1333	P-HC-4551	101-201	1/2" x 7/8"	3/8" NPS(F) Swivel
	BEDFORD PART NO.	REPLACEMENT FOR:		COMPRESSION RING FOR CONNECTOR PART NO.		
		BINKS PART NO.	GRACO PART NO.			
	12-310	72-854	104-412	12-304, 12-306		
	12-311	72-855	—	12-301, 12-305		
	12-312	72-856	104-413	12-302, 12-303		
	12-313	—	—	12-368		

To order, contact your local
Paint Spray Equipment Dealer and ask for
Genuine Bedford Replacement Parts.

BEDFORD® Replacement Parts HOSE ASSEMBLIES

LOW PRESSURE AIR & FLUID HOSE ASSEMBLIES

BULK HOSE NO.	HOSE I.D.	FITTING - THREAD	ASSEMBLY LENGTH				
			15'	25'	50'	75'	100'
			P/N	P/N	P/N	P/N	P/N
AIR HOSE ASSEMBLIES							
13-4	1/4	12-304 - 1/4 NPS(F)	13-520	13-521	13-522	13-523	13-524
13-57	5/16 C	12-301 - 1/4 NPS(F)	13-362	13-358	13-359	13-360	13-361
13-59	5/16 S	12-301 - 1/4 NPS(F)	13-366	13-354	13-355	13-356	13-357
13-6	3/8	12-302 - 3/8 NPS(F)	13-529	13-525	13-526	13-527	13-528
FLUID HOSE ASSEMBLIES							
13-470	1/4	12-306 - 3/8 NPS(F)	13-475	13-471	13-472	13-473	13-474
13-480	3/8	12-302 - 3/8 NPS(F)	13-485	13-481	13-482	13-483	13-484
13-1010	1/2	12-368 - 3/8 NPS(F)	13-1015	13-1011	13-1012	13-1013	13-1014
13-490	3/4	*12-429 - 3/4 NPT(M)	13-498	13-494	13-495	13-496	13-497

* Permanent factory-installed fittings

SUCTION HOSE ASSEMBLIES

HOSE I.D.	LENGTH	BEDFORD PART NO.	CONNECTOR THREAD INSTALLED
3/4"	3'	13-499	Hose Only (no fittings)
3/4"	3-1/2'	13-491	3/4" NPT(m) x 3/4" NPT(m)
3/4"	6'	13-492	3/4" NPT(m) x 3/4" NPT(m)
1"	4'	13-2557	Hose Only (no fittings)
1"	5'	13-2558	Hose Only (no fittings)
1"	6'	13-2556	1" NPT(m) Rigid x 1" NPT(m) Swivel

PRESSURE WASHER HOSE ASSEMBLIES

- Blue Non-Marking Cover
- Heavy Duty Bend Restrictors
- Rated for Intermittent Use up to 250°F.
- 3/8" ID Rubber Tube / Wire Braided

3/8" PRESSURE WASHER HOSE ASSEMBLIES

LENGTH	PRESSURE RATING (PSI)	BEDFORD PART NO.	CONNECTIONS / FITTINGS
50'	3000	13-2532	3/8" NPT(m) Rigid x 3/8" NPT(m) Swivel
50'	3000	13-2533	With Quick Disconnect Coupler & Plug Installed
50'	4000	13-2542	3/8" NPT(m) Rigid x 3/8" NPT(m) Swivel
50'	4000	13-2543	With Quick Disconnect Coupler & Plug Installed

PRESSURE WASHER QUICK DISCONNECT FITTINGS

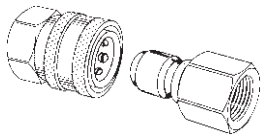
	BEDFORD PART NO.	DESCRIPTION
	12-2524	Plug - 3/8" NPT(f), Stainless Steel
	12-2525	Plug - 3/8" NPT(f), Plated Steel
	12-2526	Coupler - 3/8" NPT(f), Brass
	12-2527	Coupler - 3/8" NPT(f), Stainless Steel

AIRLESS HOSE ASSEMBLIES

Airless hose assemblies are conductive for static grounding and are 100% inspected for conductivity. Synthetic braid gives hose accumulator effect to prevent damage to pumps. Hose has a blue abrasion resistant polyurethane cover and a nylon tube. Temperature range: 0°F to +180°F.

3/16" AIRLESS HOSE ASSEMBLIES
3,500 PSI WORKING PRESSURE

Supplied with fittings as shown, and spring guards on both ends.

LENGTH	BEDFORD PART NO.	FITTINGS INSTALLED	REPLACEMENT FOR:		
			GRACO PART NO.	BINKS PART NO.	WAGNER PART NO.
2'	13-791	1/4"(M) x 1/4"(F)	214-700	—	—
3'	13-792	1/4"(M) x 1/4"(F)	214-701 / 238-358	—	—
5'	13-798	1/4"(M) x 1/4"(F)	—	71-8085	88600
6'	13-793	1/4"(M) x 1/4"(F)	214-699 / 238-359	—	—
10'	13-794	1/4"(M) x 1/4"(F)	—	71-8086	—
15'	13-795	1/4"(F) x 1/4"(F)	214-981	71-8087	—
25'	13-796	1/4"(F) x 1/4"(F)	214-698	71-8088	153000
50'	13-797	1/4"(F) x 1/4"(F)	214-697	71-8089	153001

1/4" AIRLESS HOSE ASSEMBLIES
3,300 PSI WORKING PRESSURE

Supplied with 1/4" NPS female fittings, and spring guards on both ends.

LENGTH	BEDFORD PART NO.	REPLACEMENT FOR:		
		GRACO PART NO.	BINKS PART NO.	WAGNER PART NO.
2-1/2'	13-1855	223-766	—	—
25'	13-931	223-540 / 240-793	71-7704	154014
50'	13-932	223-541 / 240-794	71-7705	154015

3/8" AIRLESS HOSE ASSEMBLIES
3,300 PSI WORKING PRESSURE

Supplied with 3/8" NPT female fittings and spring guards on both ends.

LENGTH	BEDFORD PART NO.	REPLACEMENT FOR:			
		GRACO PART NO.	BINKS PART NO.	SPEEFLO PART NO.	WAGNER PART NO.
25'	13-451	214-703 / 240-796	71-8424	225-038	88003
50'	13-453	214-705 / 240-797	71-8425	250-038	88004

To order, contact your local
Paint Spray Equipment Dealer and ask for
Genuine Bedford Replacement Parts.

BEDFORD® Replacement Parts FITTINGS & ADAPTERS

QUICK DISCONNECTS - Automatic Type - 250 PSI - For Air and Water

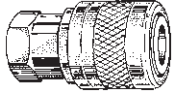
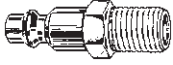

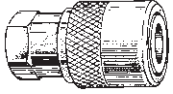
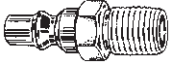
1330 SERIES	BEDFORD PART NO.	THREAD	INTERCHANGES WITH:				
			GRACO NO.	PARKER NO.	MILTON NO.	ALEMITE NO.	ARO NO.
	12-1330	1/4" NPT(f)	208-536	23 / 43	715	328030	23002-200
	12-1331	1/4" NPT(m)	—	22 / 42	716	330604	23002-212
	12-1332	1/4" NPT(f)	169-967	H3C	728	330605	23902-200
	12-1333	1/4" NPT(m)	169-970	H2C	727	328034	23902-210
	12-1334	3/8" NPT(m)	169-971	H2C-E	733	—	23902-310

1340 SERIES	BEDFORD PART NO.	THREAD	INTERCHANGES WITH:				
			GRACO NO.	PARKER NO.	MILTON NO.	ALEMITE NO.	ARO NO.
	12-1340	1/4" NPT(f)	—	53	775	—	210
	12-1341	1/4" NPT(m)	—	52	—	—	210-212
	12-1342	1/4" NPT(f)	—	A3C	778	—	2609
	12-1343	1/4" NPT(m)	—	A2C	777	—	2608

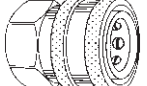
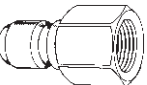
QUICK DISCONNECTS - 5000 PSI - For Pressure Washers

2520 SERIES	BEDFORD PART NO.	THREAD	INTERCHANGES WITH:	DESCRIPTION
			GRACO NO.	
	12-2526	3/8" NPT(f)	801-569	Brass Stainless Steel
	12-2527	3/8" NPT(f)	803-157	
	12-2524	3/8" NPT(f)	801-568	Stainless Steel Plated Steel
	12-2525	3/8" NPT(f)	—	

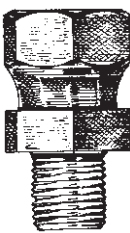
SWIVEL ADAPTER UNIONS - Plated Steel - High Pressure (5000 PSI)

	BEDFORD PART NO.	REPLACEMENT FOR:			DESCRIPTION	
		GRACO PART NO.	BINKS PART NO.	ALEMITE PART NO.	FRONT END	SWIVEL END
	12-402	156-823	41-1412	1000-44	1/4" NPT(m)	1/4" NPS(f)
	12-403	157-705	20-4468	1000-46	1/4" NPT(m)	3/8" NPS(f)
	12-404	154-986	—	1000-64	3/8" NPT(m)	1/4" NPS(f)
	12-405	155-665	20-4281	1000-66	3/8" NPT(m)	3/8" NPS(f)
	12-406	162-505	72-945	1000-68	3/8" NPT(m)	1/2" NPS(f)
	12-407	158-256	20-4067	1000-86	1/2" NPT(m)	3/8" NPS(f)
	12-465	156-684	20-4283	1000-88	1/2" NPT(m)	1/2" NPS(f)
	12-408	157-785	20-4455	—	3/4" NPT(m)	3/4" NPS(f)
	12-418	155-470	—	—	1/2" NPT(m)	1/2" NPS(f)x90°
	12-410	—	—	—	1/8" NPT(f)	1/8" NPS(f)
	12-409	155-570	83-1935	1012-44	1/4" NPT(f)	1/4" NPS(f)
	12-251	156-173	20-4256	1012-66	3/8" NPT(f)	3/8" NPS(f)
	12-411	161-077	20-4276	1012-86	1/2" NPT(f)	3/8" NPS(f)
	12-412	155-865	20-4277	1012-88	1/2" NPT(f)	1/2" NPS(f)
	12-413	156-172	20-4278	1012-1212	3/4" NPT(f)	3/4" NPS(f)
	12-201	157-676	72-918	—	1/4" NPT(f)	1/4" NPS(f)x90°
	12-431	157-416	—	—	1/2" NPT(f)	1/2" NPS(f)x90°
	12-415	156-589	—	—	3/4" NPT(f)	3/4" NPS(f)x90°

BEDFORD® Replacement Parts

FITTINGS & ADAPTERS

To order, contact your local
Paint Spray Equipment Dealer and ask for
Genuine Bedford Replacement Parts.

FULL-TIME LIVE SWIVEL CONNECTIONS - Plated Steel - 3600 PSI WPR

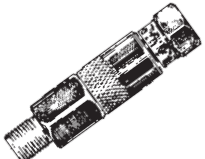
	BEDFORD PART NO.	REPLACES GRACO PART NO.	DESCRIPTION
	12-2400 12-1900	239-663 223-341	Swivel - 1/4" NPS (f) x 1/4" NPT (m) - Leather Packed Swivel - 1/4" NPS (f) x 1/4" NPT (m) - Teflon Packed

ADAPTERS - Brass - Low Pressure (750 PSI)

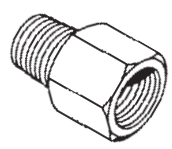
	BEDFORD PART NO.	REPLACEMENT FOR:		DESCRIPTION MALE THREAD x FEMALE THREAD
		BINKS PART NO.	DEVILBISS PART NO.	
12-599 12-1225	72-55 72-54	AD-404 P-H-4105	1/4" NPS (m) x 3/8" NPS (f) 3/8" NPS (m) x 1/4" NPS (f)	

NIPPLES - Brass - Low Pressure (750 PSI) - 30° Seat Both Ends

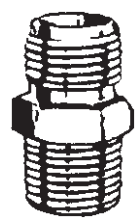
	BEDFORD PART NO.	REPLACEMENT FOR:		DESCRIPTION
		BINKS PART NO.	DEVILBISS PART NO.	
12-224	—	—	1/8" NPS x 1/8" NPS	
12-227	71-28	H-1766	1/8" NPT x 1/4" NPS	
12-221	83-1050	AD-31	1/4" NPS x 1/4" NPS	
12-222	83-576	H-2008	1/4" NPS x 1/4" NPT	
12-225	—	—	1/4" NPS x 3/8" NPS	
12-878	—	H-153	1/4" NPS x 5/8"-18	
12-879	—	H-77	3/8" NPS x 5/8"-18	
12-223	83-1294	H-1446	3/8" NPS x 3/8" NPS	

NIPPLES - Plated Steel - High Pressure (5000 PSI) - 30° Seat Both Ends

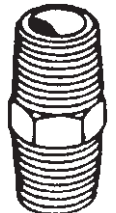
	BEDFORD PART NO.	REPLACEMENT FOR:			DESCRIPTION
		GRACO PART NO.	BINKS PART NO.	WAGNER PART NO.	
12-1978	151-519	—	—	1/8" NPT x 1/4" NPT	
12-228	156-971	—	93896	1/4" NPT x 1/4" NPT	
12-219	162-453	—	—	1/4" NPT x 1/4" NPS	
12-229	157-350	72-995	88162	1/4" NPT x 3/8" NPT	
12-230	156-849	—	88160	3/8" NPT x 3/8" NPT	
12-232	159-239	—	—	3/8" NPT x 1/2" NPT	
12-231	158-491	—	—	1/2" NPT x 1/2" NPT	



PLUGS - Plated Steel

	BEDFORD PART NO.	REPLACEMENT FOR:			DESCRIPTION
		GRACO PART NO.	BINKS PART NO.	DEVILBISS PART NO.	
12-1480	100-403	—	SS-1215	1/8" NPT - Square Head	
12-1481	100-509	86-558	SS-1216	1/4" NPT - Square Head	
12-1482	100-721	20-2288	—	1/4" NPT - Socket Head	
12-2138	—	—	—	1/4" NPT - Hex Head	
12-1483	100-040	20-1592	SS-1217	3/8" NPT - Square Head	

To order, contact your local
Paint Spray Equipment Dealer and ask for
Genuine Bedford Replacement Parts.

BEDFORD® Replacement Parts FILTERS & STRAINERS

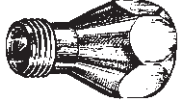
TIP FILTERS, INLINE FILTER, & ACCESSORIES

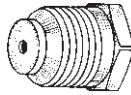

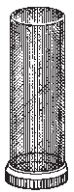

	REPLACES		BEDFORD PART NO.	DESCRIPTION
	OEM	PART NO.		
	Graco	205-264	14-151	Tip Filter, Fine, 100 Mesh
	Graco	205-265	14-152	Tip Filter, Coarse, 60 Mesh
	Binks	54-1835	14-1161	Tip Filter, Fine, 100 Mesh
	Binks	54-1836	14-1162	Tip Filter, Coarse, 60 Mesh
	Graco	164-120	12-620	Tip Filter Housing Stainless Steel, 7/8"(f) - 11/16"(m) Threads (May also be used as an adapter to convert from "G" gun thread to "F" tip base thread)
	Graco	210-500	14-1200	Inline Filter Assembly (Stainless Steel) 1/4" NPS(f) x 1/4" NPS(m) (Includes (1) Fine Tip Filter)
	Graco	181-084	12-1587	Adapter - Binks Gun to Graco Tip Base (3/4"(f) "B" Thread - 7/8"(m) "G" Thread)
	Graco	181-085	12-1486	Adapter - Wagner / Airlessco / ASM Guns to Graco Tip Base (11/16"(f) "F" Thread - 7/8"(m) "G" Thread)

Note: Replacement for Graco 212-058 - Order (1)8-122, (1)12-620, (1)14-151, (1)14-152

AIR & FLUID INLINE STRAINER ELEMENTS

	REPLACES		BEDFORD PART NO.	MESH	DESCRIPTION
	OEM	PART NO.			
	Binks	83-2705	14-1731	30	Filter Element
	Binks	83-2089	14-1732	50	Filter Element
	Binks	83-2596	14-1733	80	Filter Element
	Binks	83-1256	14-1734	100	Filter Element
	Binks	83-2405	14-1735	150	Filter Element
	Binks	83-2706	14-1736	200	Filter Element

AIRLESS GUN FILTERS



	REPLACES		BEDFORD PART NO.	MESH	DESCRIPTION
	OEM	PART NO.			
	Graco	287-032	14-2664	60	Contractor II / FTx II Gun Filter - Black
	Graco	287-033	14-2665	100	Contractor II / FTx II Gun Filter - Blue
	Graco	287-034	14-2648	60 & 100	Contractor II / FTx II Gun Filters - Twin-Pack
	Graco	218-131	14-1484	50	Contractor Gun Filter Assembly - Coarse
	Graco	218-133	14-1485	100	Contractor Gun Filter Assembly - Fine
	Graco	179-731	14-1118	50	Contractor Gun Filter Element - Coarse
	Graco	179-732	14-1120	100	Contractor Gun Filter Element - Fine
	Wagner	89323	14-831	30	G-10 Gun Filter - Coarse (Green)
	Wagner	34377	14-832	50	G-10 Gun Filter - Medium (White)
	Wagner	89324	14-833	100	G-10 Gun Filter - Fine (Yellow)
	Wagner	34383	14-834	180	G-10 Gun Filter - Extra Fine (Red)
	Titan	500-200-03	14-2171	30	LX-80 Gun Filter, 2-pack - Coarse (Green)
	Titan	500-200-06	14-2172	60	LX-80 Gun Filter, 2-pack - Medium (White)
	Titan	500-200-10	14-2173	100	LX-80 Gun Filter, 2-pack - Fine (Yellow)
	Titan	500-200-15	14-2174	150	LX-80 Gun Filter, 2-pack - Extra Fine (Red)

BEDFORD® Replacement Parts

FILTERS & STRAINERS

To order, contact your local
Paint Spray Equipment Dealer and ask for
Genuine Bedford Replacement Parts.

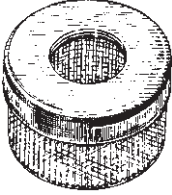
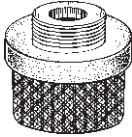
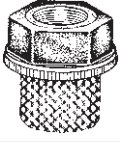
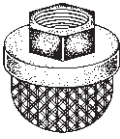
INLET STRAINERS ("Rock Catchers")

	REPLACES		BEDFORD PART NO.	MESH	SIZE / DESCRIPTION
	OEM	PART NO.			
	Stainless Steel Cap, Stainless Steel Screen				
	Airlessco	141-008	14-1817	16	3/4" NPT, Double Screen
	Amspray	2975	14-1325	8	3/4" NPT, Single Screen
	Amspray	2976	14-1329	16	3/4" NPT, Double Screen
	Binks	41-10094	14-674	16	3/4" NPT, Double Screen
	Graco	181-072	14-1223	16	1" NPT, Stainless Steel Cap, Double Screen
	Graco	181-073	14-1224	16	1/2" NPT, Stainless Steel Cap, Double Screen
	Graco	183-770	14-1428	16	3/4" NPT, Stainless Steel Cap, Double Screen
	Graco	189-920	14-2179	8	1" NPT, Single Screen
	H.E.R.O.	187A	14-2332	16	3/4" NPT, Double Screen
	Wagner	88241	14-856	10	Large Metric, Single Screen
	Nylon Cap, Stainless Steel Screen - Order by Bedford P/N:				
	Graco	181-072(P)	14-2353	16	1" NPT, Nylon Cap, Double Screen
Graco	181-073(P)	14-2351	16	1/2" NPT, Nylon Cap, Double Screen	
Graco	183-770(P)	14-2352	16	3/4" NPT, Nylon Cap, Double Screen	
	Graco	243-082	14-2530	36	3/4" Garden Hose Thread for Magnum Pumps
	Graco	235-004	14-1964	12	3/4" UNF Thread for 390st & Nova SP
	Graco Titan Titan Wagner	246-385 700-805 710-046 5006536	14-2649 14-2081 14-2082 14-2682	12 10 10 10	7/8" UNF Thread for Ultra 395/495 Pumps 3/4" UNF Thread for all Epic Series Pumps 1-5/16" Thread for all Elite Series Pumps 1-5/16" Thread for EPX/GPX Pumps
	Graco Graco Graco Graco	207-241 210-726 207-240 238-769	14-700 14-900 14-370 14-2170	60 60 60 60	Wire Cage & Bag for 3/4" OD Tube Wire Cage & Bag for 1-1/4" OD Tube Replacement Filter Bags (12-Pack) Replacement Filter Bags (25-Pack)
	Speeflo Speeflo Wagner	103-625 103-627 509762	14-2297 14-2299 14-2748	10 10 10	Inlet Strainer Assembly for 1" OD Tube Inlet Strainer Assembly for 1-1/4" OD Tube Inlet Strainer Assembly for 1-1/4" OD Tube



INLET SUMP FILTER ELEMENTS

	REPLACES		BEDFORD PART NO.	MESH	DESCRIPTION
	OEM	PART NO.			
	Speeflo	103-628	14-904	30	Inlet Sump Filter Element
	Speeflo	103-624	14-905	50	Inlet Sump Filter Element

To order, contact your local
Paint Spray Equipment Dealer and ask for
Genuine Bedford Replacement Parts.

BEDFORD® Replacement Parts FILTERS & STRAINERS

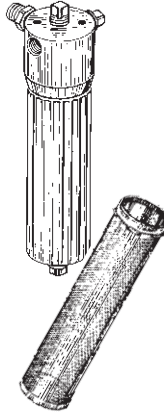
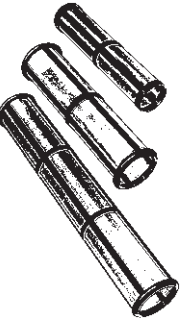
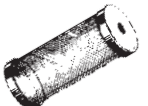
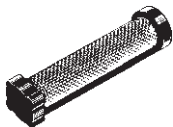
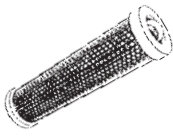
FLUID OUTLET MANIFOLD ASSEMBLY & OUTLET FILTERS

	REPLACES		BEDFORD PART NO.	MESH	DESCRIPTION
	OEM	PART NO.			
	Graco	214-570	14-1566	60	Fluid Outlet Manifold Filter - Complete Assembly
	Amspray	4339	14-1489	50	Fluid Outlet Strainer
	Amspray	4340	14-1490	100	Fluid Outlet Strainer
	Amspray	14068	14-2596	100	Fluid Outlet Strainer (solid end cap)
	Amspray	14069	14-2595	50	Fluid Outlet Strainer (solid end cap)
	Graco	167-024	14-184	30	Fluid Outlet Strainer (Long)
	Graco	167-025	14-185	60	Fluid Outlet Strainer (Long)
	Graco	167-026	14-186	100	Fluid Outlet Strainer (Long)
	Graco	167-027	14-187	200	Fluid Outlet Strainer (Long)
	Titan	730-067-30	14-2096	30	Fluid Outlet Strainer - for Epic 660ex, 690gx, Promark 690
	Titan	730-067	14-2097	60	Fluid Outlet Strainer - for Epic 660ex, 690gx, Promark 690
	Titan	730-067-10	14-2098	100	Fluid Outlet Strainer - for Epic 660ex, 690gx, Promark 690
	Titan	761-043	14-2101	60	Fluid Outlet Strainer - for all Elite Pumps
Wagner	508748	14-2747	60	Fluid Outlet Strainer - EPX / GPX	
	Graco	246-384	14-2675	60	Fluid Outlet Strainer, Short, Black
	Graco	246-382	14-2676	100	Fluid Outlet Strainer, Short, Blue
	Graco	243-080	14-2685	60	Fluid Outlet Strainer, Medium, Black
	Graco	243-081	14-2686	100	Fluid Outlet Strainer, Medium, Blue
	Graco	243-226	14-2687	200	Fluid Outlet Strainer, Medium, Red
	Graco	244-071	14-2694	30	Fluid Outlet Strainer, Long, Gray
	Graco	244-067	14-2695	60	Fluid Outlet Strainer, Long, Black
	Graco	244-068	14-2696	100	Fluid Outlet Strainer, Long, Blue
	Graco	244-069	14-2697	200	Fluid Outlet Strainer, Long, Red
	Graco	167-052	14-192	30	Fluid Outlet Strainer (Short)
	Graco	167-053	14-193	60	Fluid Outlet Strainer (Short)
	Graco	167-054	14-194	100	Fluid Outlet Strainer (Short)
	Graco	167-055	14-195	200	Fluid Outlet Strainer (Short)
	Graco	243-070	14-2650	30	Fluid Outlet Filter - for Magnum XR Pumps
	Speeflo	920-004	14-2265	50	Fluid Outlet Strainer
	Speeflo	920-005	14-2266	100	Fluid Outlet Strainer
	Speeflo	930-005	14-2344	5	Fluid Outlet Strainer with Check Ball
	Speeflo	930-006	14-2346	50	Fluid Outlet Strainer with Check Ball
	Speeflo	930-007	14-2347	100	Fluid Outlet Strainer with Check Ball
	Titan	500-200-03	14-2171	30	Fluid Outlet Strainer, green (2-pack) - for Epic 440e, 447ex
	Titan	500-200-06	14-2172	60	Fluid Outlet Strainer, white (2-pack) - for Epic 440e, 447ex
	Titan	500-200-10	14-2173	100	Fluid Outlet Strainer, yellow (2-pack) - for Epic 440e, 447ex
	Titan	500-200-15	14-2174	150	Fluid Outlet Strainer, red (2-pack) - for Epic 440e, 447ex
	Binks	41-2627	14-345	100	Fluid Outlet Filter Screen (Long)
	Binks	41-2628	14-346	60	Fluid Outlet Filter Screen (Long)
	Binks	41-2629	14-347	50	Fluid Outlet Filter Screen (Long)

BEDFORD® Replacement Parts

SPRAY GUN REPAIR PARTS

To order, contact your local Paint Spray Equipment Dealer and ask for Genuine Bedford Replacement Parts.

CONVENTIONAL & HVLP SPRAY GUN REPAIR PARTS

SPRAY GUN	REPLACES OEM PART NO.	BEDFORD PART NO.	DESCRIPTION
Binks Model 7	6-188	20-324	Repair Kit
Binks Model 18	6-189	20-328	Repair Kit
Binks Model 69	6-195	20-329	Repair Kit
Binks Model 95	54-3577	20-2154	Repair Kit
Binks Model 2001	6-229	20-1175	Repair Kit
Binks MACH I / BBR	54-3605	20-1880	Repair Kit
	54-3980	20-2340	Repair Kit (For Automatic Guns)
DeVilbiss JGA JGV JGK JGHV GFG LMG LMK MSA MSV PGA	KK-4987-2	20-2055	Repair Kit
DeVilbiss MBC	KK-4058-1	20-1146	Repair Kit
DeVilbiss JGHV (HVLP)	KK-4911	20-1596	Repair Kit
Kremlin MX / MR	129.659.901	20-2504	Repair Kit (Package of 3 seals each)
Sharpe 71	16000	20-1794	Repair Kit
Sharpe 75PI	16000	20-1794	Repair Kit
Sharpe 775 PI	25196	20-1795	Repair Kit
Titan HVLP	770-389	20-2150	O-Ring Repair Kit

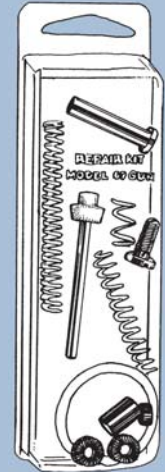

AIRLESS SPRAY GUN REPAIR PARTS

SPRAY GUN	REPLACES OEM PART NO.	BEDFORD PART NO.	DESCRIPTION
AIRLESSCO 007	120-011	58-2001	Valve Spring Unit Assembly
	120-035	58-2022	Valve Seat (Diffuser) Assembly
	120-037	58-2024	Ball & Holder Assembly
	KIT-2-007	20-2031	Minor Repair Kit - includes: Ball & Holder Assy, Valve Seat Assy, (2) Teflon Seals, (3) Tip Washers
	KIT-3-007	20-2032	Complete Repair Kit - includes: Ball & Holder Assy, Valve Seat Assy, Valve Spring Unit (complete), (3) Tip Washers
ASM 300 & 400	4402-F	58-2232	Diffuser with TC Seat (11/16 "F" Thd)
	4402-G	58-2385	Diffuser with TC Seat (7/8 "G" Thread)
	4404	47-2227	Ball Mount & Valve Plunger Assembly
	4405	47-2229	Ball Mount with TC Ball
	4426-F	20-2233	Minor Kit - Diffuser ("F") & Ball Mount
	4426-G	20-2392	Minor Kit - Diffuser ("G") & Ball Mount
	4427-F	20-2234	Gun Repair Kit - Includes: Diffuser ("F"), Ball Mount & Valve Plunger Assy
	4427-G	20-2393	Gun Repair Kit - includes: Diffuser ("G"), Ball Mount & Valve Plunger Assy
	4428	47-2235	Valve Plunger Assembly
	4433-2	55-2721	Gun Filters - 50 Mesh (2-pack)
4434-2	55-2722	Gun Filters - 50 Mesh (2-pack)	
GRACO SILVER GUN: 208-327 208-663 208-664 220-954 GRACO FLEX GUN: 218-132 220-956	218-143	20-1401	Gun Repair Kit - Includes the following: (1) Fluid Needle & Ball Holder Assy (1) Diffuser Housing & Seat Assy (1) Tip Washer (1) Diffuser Gasket



To order, contact your local
Paint Spray Equipment Dealer and ask for
Genuine Bedford Replacement Parts.

BEDFORD® Replacement Parts SPRAY GUN REPAIR PARTS

AIRLESS SPRAY GUN REPAIR PARTS (Continued)



Contractor II and FTx-II Guns

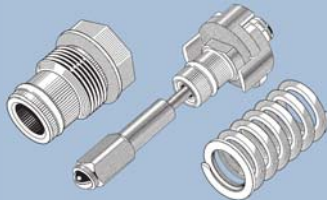

G-10 Gun

SPRAY GUN	REPLACES OEM PART NO.	BEDFORD PART NO.	DESCRIPTION
GRACO CONTRACTOR: 217-593 220-955 235-990 243-282 820-165 824-950 CONTRACTOR FTx: 238-350 239-045 239-516 243-285 243-374 243-375 824-004 CONTRACTOR ST: 238-352 SG3: 243-238 243-382	218-021	47-2062	Swivel Assembly for Gun Handle
	218-070	20-1502	Gun Repair Kit - Includes the following: (1) Fluid Needle & Ball Holder Assembly (1) Diffuser Assembly (1) Tip Washer, (1) Locknut, (1) Diffuser Gasket
	218-131	14-1484	Fluid Filter Assembly (50 Mesh)
	218-133	14-1485	Fluid Filter Assembly (100 Mesh)
GRACO SILVER +PLUS+ GUN: 235-460 thru 235-464 236-531 237-695 238-591 238-941 238-966 243-283 246-240 FLEX +PLUS+ GUN: 235-457 235-458 235-459 237-691 243-284 246-468	235-474	20-1930	Gun Repair Kit - Includes the following: (1) Fluid Needle Assembly (1) Diffuser Seat Assembly (1) Tip Washer (1) Diffuser Gasket
	GRACO CONTRACTOR II: 246-220 246-221 246-222 246-224 246-225 246-434 246-538 824-987 CONTRACTOR FTx-II: 246-230 thru 246-235 246-435 246-539 246-540	287-031	20-2701
287-032		14-2664	Gun Filter, 60 Mesh, Medium, Black
287-033		14-2665	Gun Filter, 100 Mesh, Fine, Blue
TITAN LX-80 GUN	500-200-03	14-2171	Gun Filter, 30 Mesh, Coarse, Green (2-pack)
	500-200-06	14-2172	Gun Filter, 60 Mesh, Medium, White (2-pack)
	500-200-10	14-2173	Gun Filter, 100 Mesh, Fine, Yellow (2-pack)
	500-200-15	14-2174	Gun Filter, 150 Mesh, Extra-Fine, Red (2-pk)
	580-034	20-2095	Gun Repair Kit - Includes the following: Needle Assy, Diffuser Seat Assembly, Diffuser Gasket, Locknut
TITAN SGX-20 GUN	520-025	20-2088	Gun Repair Kit - Includes the following: Needle Assy, Diffuser Seat Assembly, Diffuser Gasket
WAGNER "G-10" SPRAY GUNS: G-9 / G-9N G-10 / G-10N Parts are also compatible with Amspray EZ-3000 & Larius AT-250 spray guns.	34377	14-832	Filter, Medium (White, 50 Mesh)
	34383	14-834	Filter, Extra-Fine (Red, 180 Mesh)
	43225	58-1495	11/16" Diffuser Housing & Seat Assembly
	89323	14-831	Filter, Coarse (Green, 30 Mesh)
	89324	14-833	Filter, Fine (Yellow, 100 Mesh)
	149342	58-2016	7/8" Diffuser - G10 with Graco "G" Thread
	149700	58-2305	Needle Assembly
	270957	20-1751	Gun Repair Kit - Includes the following: Valve Spring Unit & Ball Holder Assembly, 11/16" Diffuser Assy, X-Fine Filter, Med Filter, Spring, (2) Swivel Washers, (2) Tip Washers, (2) Handle Washers, Locknut
	279625	20-2300	Gun Repair Kit - Includes the following: Valve Spring Unit & Ball Holder Assembly, 7/8" Diffuser Housing & Seat Assembly, Spring, Locknut, Swivel Washer, Tip Washer, Upper Handle Washer
	279919	20-2160	Gun Repair Kit - Includes the following: Valve Spring Unit & Ball Holder Assembly, 7/8" Diffuser Housing & Seat Assembly, Spring, Locknut, Swivel Washer, Tip Washer, Upper Handle Washer
347706	47-2450	Gun Handle Swivel Assembly & Washer	
WAGNER G-10XL and G-12XL	296261	58-2735	Diffuser Seat Assembly
	296294	20-2737	Gun Repair Kit - Includes the following: Needle Assy, Diffuser Seat Assembly, Locknut

AIR PRESSURE REGULATORS

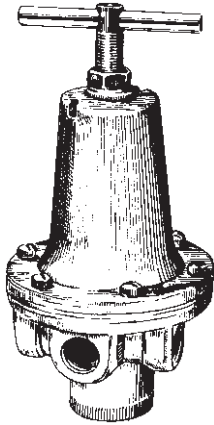

HEAVY DUTY SERIES

Ideal for high capacity continuous service. Relieving type regulators are available in sizes from 1/4" to 1", all sizes have two 1/4" gauge ports.

SPECIFICATIONS

Maximum Initial Pressure 300 PSI
 Output Pressure Range 0-125 PSI
 Operating Temperature Range 40°-120°F

SIZE	MAX SCFM	BEDFORD PART NO.
1/4"	60	26-712
3/8"	90	26-713
1/2"	200	26-714
3/4"	380	26-716
1"	380	26-718

TYPICAL PERFORMANCE FLOW CURVES

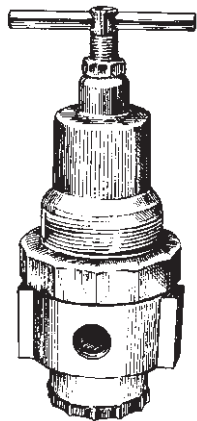
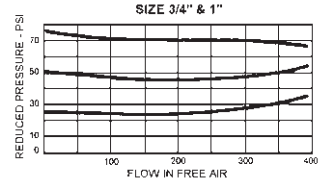
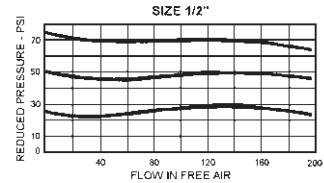
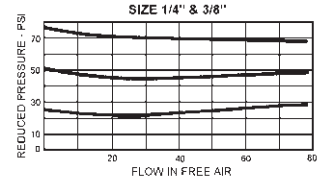

GENERAL PURPOSE SERIES

STANDARD MODEL

With same operating pressure and temperature range as the heavy duty series, this regulator is an economical unit where flow requirements do not exceed 80 SCFM.

1/4" inlet and outlet with two regulated 1/4" gauge ports.

REPLACES DEVILBISS PART NO.	BEDFORD PART NO.
HAR-505	26-1125

SERIES INSTALLATION MODELS

P/N 26-1119 has 3/8" inlet, two 1/4" unregulated ports, and 1/2" regulated outlet.

P/N 26-2328 has 1/4" inlet, 1/4" unregulated port, and two 1/4" regulated outlets.

Specifications same as standard model.

REPLACES DEVILBISS PART NO.	BEDFORD PART NO.
HAR-502	26-2328
HAR-555	26-1119

GAUGES

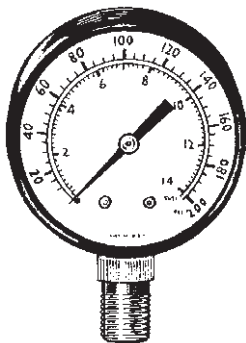

CONNECTION (MALE)	MOUNT	PRESSURE RANGE (PSI)	DIAL DIAMETER	BEDFORD PART NO.
1/8" NPT	BOTTOM	0-60	1-1/2"	28-1358
1/8" NPT	REAR	0-160	1-1/2"	28-706
1/4" NPT	BOTTOM	0-60	2"	28-721
1/4" NPT	BOTTOM	0-100	2"	28-759
1/4" NPT	BOTTOM	0-160	2"	28-766
1/4" NPT	REAR	0-160	2"	28-705
1/4" NPT	BOTTOM	0-160	2-1/2"	28-875
1/4" NPT	BOTTOM	0-200	2"	28-719
1/4" NPT	BOTTOM	0-200	2"	28-1655
1/4" NPT	REAR	0-300	2"	28-704
1/4" NPT	REAR	0-3000	2"	28-1079

To order, contact your local
Paint Spray Equipment Dealer and ask for
Genuine Bedford Replacement Parts.

BEDFORD® Replacement Parts AIR CONTROL COMPONENTS

FILTERS

Two stage filtration effectively removes airline scale, dirt and moisture. Available in three models listed below with 40 Micron filter element, sizes from 1/4" to 1".

UNIT WITH TRANSPARENT BOWL & GUARD			
SIZE	PART NO.	MAX SCFM	BOWL SIZE
1/4"	25-722	55	5 oz.
3/8"	25-723	75	5 oz.
1/2"	25-724	100	8 oz.

UNIT WITH METAL BOWL & SIGHT GLASS			
SIZE	PART NO.	MAX SCFM	BOWL SIZE
3/4"	25-726	250	16 oz.
1"	25-728	350	16 oz.

UNIT WITH OVERSIZED METAL BOWL			
SIZE	PART NO.	MAX SCFM	BOWL SIZE
1/2"	25-744	100	16 oz.
3/4"	25-746	250	32 oz.
1"	25-748	350	32 oz.

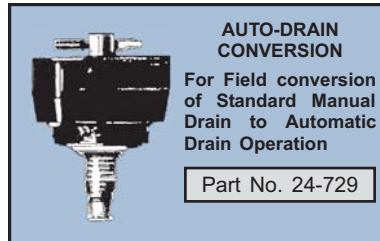

AUTO-DRAIN CONVERSION

For Field conversion
of Standard Manual
Drain to Automatic
Drain Operation

Part No. 24-729

SPECIFICATIONS

Maximum Supply Pressure	(PSI)
Transparent Bowl	150
Metal Bowl w/ Sight Glass	250
Oversized Metal Bowl	300
Operating Temperature	(°F)
Transparent Bowl	40°-120°
Metal Bowl w/ Sight Glass	40°-150°
Oversized Metal Bowl	40°-180°

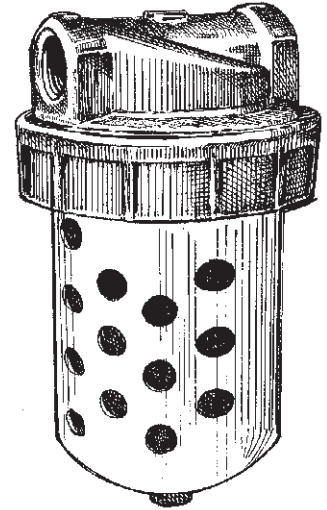

LUBRICATORS

Dial set adjustment and full view drip tube for simple operation. Unit may be filled while pressurized without shutting down equipment. Available in three models listed below, sizes from 1/4" to 1".

UNIT WITH TRANSPARENT BOWL & GUARD			
SIZE	PART NO.	MAX SCFM	BOWL SIZE
1/4"	27-732	40	5 oz.
3/8"	27-733	70	5 oz.
1/2"	27-734	112	8 oz.

UNIT WITH METAL BOWL & SIGHT GLASS			
SIZE	PART NO.	MAX SCFM	BOWL SIZE
3/4"	27-736	290	16 oz.
1"	27-738	320	16 oz.

UNIT WITH OVERSIZED METAL BOWL			
SIZE	PART NO.	MAX SCFM	BOWL SIZE
1/2"	27-754	112	16 oz.
3/4"	27-756	290	32 oz.
1"	27-758	320	32 oz.

SPECIFICATIONS

Maximum Supply Pressure	(PSI)
Transparent Bowl	150
Metal Bowl w/ Sight Glass	250
Oversized Metal Bowl	300
Operating Temperature	(°F)
Transparent Bowl	40°-120°
Metal Bowl w/ Sight Glass	40°-150°
Oversized Metal Bowl	40°-180°

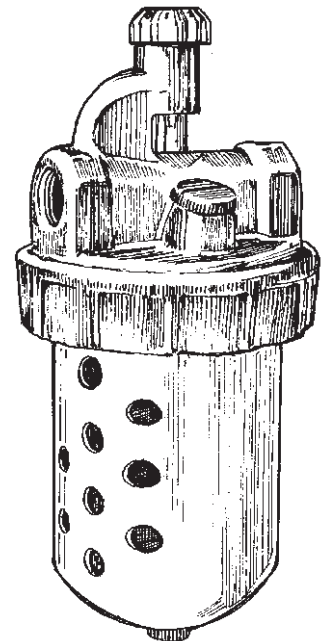

MINIATURE SERIES

These components are specifically designed for applications where a small economical unit is required. Especially useful on air tools, cylinders, valves, paint sprayers, and pressurized tanks.

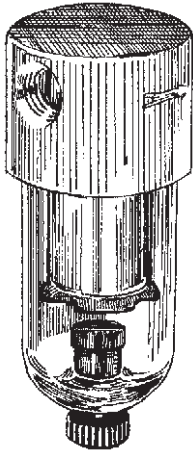

MINI FILTER

Two stage filtration removes airline scale, dirt and moisture. Has 20 Micron filter element, aluminum body, and shatterproof clear polycarbonate bowl. Connections are 1/4" and the bowl capacity is 1 oz.

SPECIFICATIONS

Flow 22.0 SCFM
Maximum Supply Pressure 150 PSI
Operating Temperature 40°-120° F
Height: 4" Dia: 1-9/16" Weight: 1/4 lb

PART NO.

25-720

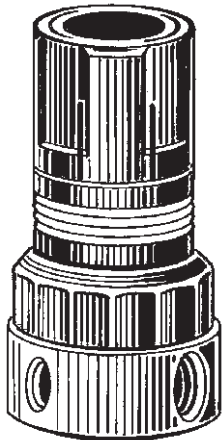
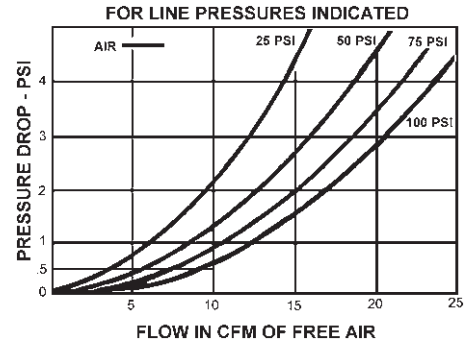

MINI REGULATOR

Relieving type regulator has aluminum body and acetyl spring cage and adjusting knob. 1/4" inlet and outlet ports with two 1/8" gauge ports for use with P/N 28-706 & 28-1358 gauges.

SPECIFICATIONS

Flow 16.0 SCFM
Maximum Supply Pressure 300 PSI
Output Pressure Range 0-125 PSI
Operating Temperature 40°-120° F
Height: 3" Dia: 1-9/16" Weight: 1/4 lb

PART NO.

26-710

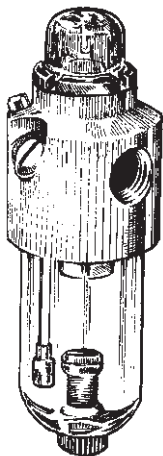
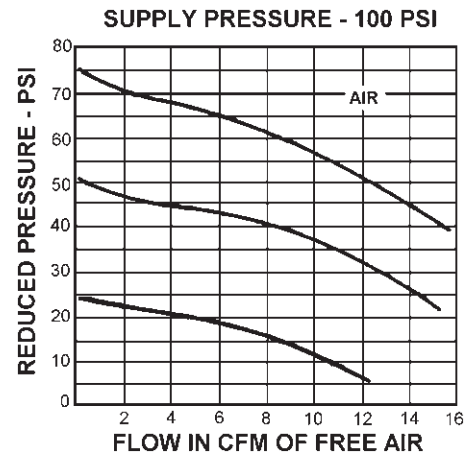

MINI LUBRICATOR

Unit has rugged aluminum body and shatterproof clear polycarbonate bowl and two large fill ports for quick filling. Connections are 1/4". 1 oz. bowl capacity.

SPECIFICATIONS

Flow 12.0 SCFM
Maximum Supply Pressure 150 PSI
Operating Temperature 40°-120° F
Height: 4-7/16" Dia: 1-9/16" Weight: 1/4 lb

PART NO.

27-730

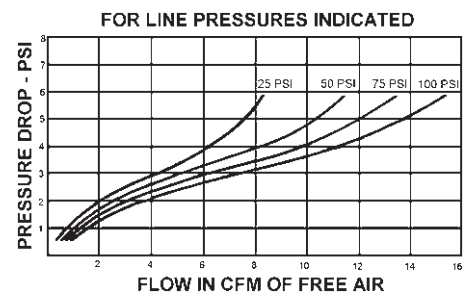

To order, contact your local
Paint Spray Equipment Dealer and ask for
Genuine Bedford Replacement Parts.

BEDFORD® Replacement Parts

AIR CONTROL COMPONENTS

AIR RELIEF SAFETY VALVE

Air relief safety valves have all brass body construction with stainless steel ball, forming metal to metal valve seal assuring reliable performance and long life. 1/4" NPT male connection. Maximum temperature 300° F. ASME Approved.

DESCRIPTION	RELIEF PRESSURE (PSI)	BEDFORD PART NO.
Air Relief Safety Valve	80	29-1676
	110	29-941



AIR CONTROL COMPONENT REPLACEMENT PARTS

REGULATOR REPAIR PARTS

DESCRIPTION	FOR UNIT NO.	BEDFORD PART NO.
Repair Kit	26-1119, 26-1125, 26-2328	24-1126
Repair Kit	26-712 & 26-713	24-725
Repair Kit	26-714	24-727
Repair Kit	26-716 & 26-718	24-731
Cage & Knob	26-710	24-1023
T-Handle & Cage	26-1119, 26-1125, 26-2328	24-1024
T-Handle	26-712 & 26-713	24-1020
T-Handle	26-714	24-1021
T-Handle	26-716 & 26-718	24-1022

REPLACEMENT TRANSPARENT BOWL

DESCRIPTION	FOR UNIT NO.	BEDFORD PART NO.
Bowl	25-720 & 27-730	24-1030
Bowl with Guard	All 1/4" & 3/8"	24-739
Bowl with Guard	All 1/2"	24-740
Drain Cock	Transparent Bowls	24-1038

REPLACEMENT METAL BOWL WITH SIGHT GLASS

DESCRIPTION	FOR UNIT NO.	BEDFORD PART NO.
Bowl	All 3/4" & 1"	24-741
Sight Glass Only	24-741 Bowl	24-1037

FILTER REPAIR PARTS

DESCRIPTION	FOR UNIT NO.	BEDFORD PART NO.
Filter Element	25-720	24-1028
Filter Element	All 1/4" & 3/8"	24-814
Filter Element	All 1/2"	24-815
Filter Element	All 3/4" & 1"	24-816
Baffle Assembly	All 1/4" & 3/8"	24-1025
Baffle Assembly	All 1/2"	24-1026
Baffle Assembly	All 3/4" & 1"	24-1027

MOUNTING BRACKETS

DESCRIPTION	FOR UNIT NO.	BEDFORD PART NO.
Bracket & Nut	Mini-Regulator	24-1968
Nut Only	Mini-Regulator	24-1972
Bracket & Nut	26-1125, 26-1119, 26-2328	24-1969
Nut Only	26-1125, 26-1119, 26-2328	24-1973
Bracket	26-712 & 26-713	24-1970
Bracket	26-714	24-1971

LUBRICATOR REPAIR PARTS

DESCRIPTION	FOR UNIT NO.	BEDFORD PART NO.
Cap, Tube & O-Ring	All Standard Units	24-1029
Adjusting Cap	All Standard Units	24-1035
Filler Plug	All Standard Units	24-1033
Repair Kit	All Standard Units	24-1031

BEDFORD® Replacement Parts

Technical Data

To order, contact your local
Paint Spray Equipment Dealer and ask for
Genuine Bedford Replacement Parts.

Chemical Resistance of Materials – Fluid Compatibility Data

Type of Fluid	NY	TE	VI	LE
Acetate Solvents	1	1	0	0
Acetic Acid	3	1	3	3
Acetone	1	1	3	2
Acetylene	1	1	1	1
Air	1	0	0	0
Air (Hot)	1	0	0	0
Alcohols	2	1	1	1
Ammonia (Anhydrous) Liquid	3	1	3	3
Ammonia (Gas)	2	0	0	0
Ammonium Hydroxide	2	1	1	2
Ammonium Chloride	3	1	1	0
Aniline	3	1	2	0
Aliphatic Hydrocarbons	1	0	0	0
Aromatic Hydrocarbons	1	0	0	0
Auto Transmission Fluid	1	0	0	0
Barium Chloride	3	1	1	1
Barium Sulphide	2	1	1	1
Benzene (Benzol)	1	1	3	2
Boric Acid	2	1	1	1
Bromine	3	1	1	3
Butane	1	1	1	2
Butyl Alcohol (Butanol)	2	1	0	0
Butyl Acetate	1	1	3	2
Calcium Chloride	2	1	1	1
Carbolic Acid	3	1	1	3
Carbonic Acid	2	1	1	1
Chlorine (Wet)	3	1	0	0
Chloro Methane (Methylene Chloride)	2	1	1	0

Type of Fluid	NY	TE	VI	LE
Citric Acid	2	1	1	0
Cresol	3	1	1	3
Diesel Fuel	1	1	1	1
Ethanol	2	1	1	2
Ethers	1	1	3	2
Ethyl Acetate	1	1	3	2
Ethylene Glycol ●	2	1	1	0
Formaldehyde	2	1	1	3
Gasoline	1	1	1	1
Hydraulic Fluid (Petroleum Based)	1	1	1	1
Hydraulic Fluid (Phosphate Ester) ●	2	1	1	2
Hydraulic Fluids (Water/Glycol) ●	2	1	0	0
Hydrochloric Acid	3	1	1	2
Hydrogen Peroxide	3	1	1	1
Isopropyl Alcohol	2	1	1	2
Isocyanates ▲	3	0	0	0
Kerosene	1	1	1	1
Ketones	1	1	3	2
Lacquers & Solvents	1	1	3	2
Linseed Oil	1	1	1	1
Lubricating Oils (Petroleum Base)	1	1	1	1
Lubricating Oils (Diester Base)	1	0	0	0
Mercury	1	1	1	1
Mercuric Chloride	2	1	1	0
Methanol	2	1	1	2
Methyl Ethyl Ketone (MEK)	1	1	3	2
Methylene Chloride	2	1	1	0
Mineral Oil	1	1	1	1

Type of Fluid	NY	TE	VI	LE
Naphtha	1	1	1	1
Natural Gas	1	1	0	0
Nitric Acid (70%)	3	3	0	0
Oleic Acid	2	1	1	1
Oxalic Acid	2	1	1	2
Oxygen	2	3	0	0
Paint (Oil / Alkyn Based)	1	1	2	1
Paint (Water Based) ●	1	1	1	1
Phenol	3	1	2	3
Potassium Salt Solutions	2	1	0	0
Refrigerant 12	1	0	0	0
Refrigerant 22	1	0	0	0
Refrigerant 502	1	0	0	0
Sodium Chloride Solution	2	1	1	1
Sodium Hydroxide (<20%)	2	1	1	3
Sodium Hypochlorite Solution	3	1	1	0
Steam	3	0	0	0
Sulphuric Acid	3	1	1	3
Trichlorethylene	2	1	0	0
Toluene (Toluol)	1	1	2	2
Turpentine	1	1	1	2
Varnishes & Solvents	1	1	0	2
Water, Fresh (Cold)	1	1	1	1
Water, Salt (Cold)	2	1	1	1
Water, Fresh (Hot over 66°C)	3	1	1	3
Water, Salt (Hot over 66°C)	3	1	1	3
Xylene	1	1	3	2
Zinc Chloride Solutions	3	1	1	1

MATERIAL CODE: NY - Nylon TE - Teflon VI - Viton LE - Leather

RESISTANCE CODE: 1 - Little or no effect 2 - Minor or moderate effect 3 - Severe Effect 0 - Not tested

● Recommended operating temperature not to exceed 160°F

▲ Precautions must be taken to keep moisture from permeating hose

*The information given is based on research and experience and to the best of our knowledge is reliable.
However, we must emphasize that the chart should be used as a guide only.*

Pipe Thread Sizing Guide

To size a **Male NPT or NPS thread**, determine which of the guide circles below best represents the thread's **outside diameter**.



To size a **Female NPT or NPS thread**, determine which of the guide circles below best represents the thread's **inside diameter**.

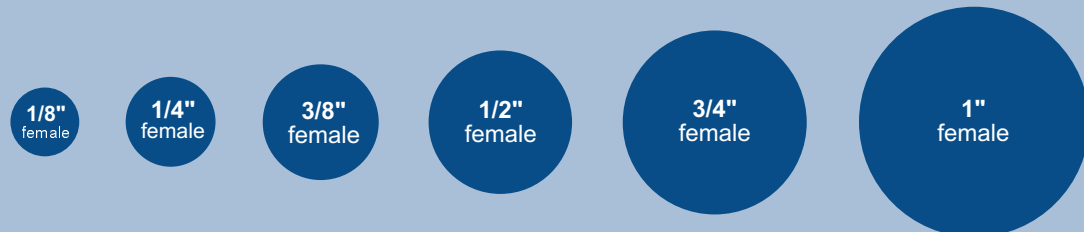

To order, contact your local
Paint Spray Equipment Dealer and ask for
Genuine Bedford Replacement Parts.

BEDFORD® Replacement Parts Index

ITEM	PAGE
ADAPTERS	
Low Pressure	71, 72
Swivel Unions, High Pressure	71
AIR CONTROL COMPONENTS	
Filters, Air Line	79
Lubricators, Air Line	79
Miniature Series	80
Regulators, Air Line	78
AIRLESSCO	
Glidden Pumps, Quick Reference	17
Pump Kits, Quick Reference	4
Replacement Parts for	4-6
Spray Guns, Quick Reference	4, 76
AMSPRAY	
Glidden Pumps, Quick Reference	17
Pump Components, Quick Reference	58
Replacement Parts for	60-63
ASM	6, 76
BINKS	
Pump Components, Quick Reference	7
Replacement Parts for	7-14
Spray Guns, Quick Reference	7, 76
CLOTHING, Disposable, Protective	64
CONNECTORS, Hose	68
COUPLINGS	
Hose	68
Quick Disconnect	69, 71
CUP ASSEMBLY, Quart Siphon	67
DEVILBISS	
Replacement Parts for	15-16
Spray Guns, Quick Reference	14, 76
FILTERS	
Airless Gun	73
Air Line	79-80
Air Line, Miniature	80
Inlet Strainers	74
Inline, Fluid	73
Manifold	75
Tip	73
FITTINGS, Hose	68-72
FULLER O'BRIEN, Pump Interchange	58
GASKETS, Cup and Tank Lid	65
GAUGES	78
GLIDDEN	
Airlessco Private Label, Pump Kits	17
Amspray Private Label, Pump Components	17, 58
Wagner Private Label, Pump Kits	17, 58-59
GRACO	
Pump Components, Quick Reference	18-25
Replacement Parts for	26-44
Spray Guns, Quick Reference	25, 77
GUN, Spray, Repair Parts	76-77
H.E.R.O.	
Pump Components, Quick Reference	45
Replacement Parts for	46-47
HOSE	
Air & Fluid, Low Pressure	68-69
Airless Spray	70
Pressure Washer	69
KREMLIN	57
LARIUS	57
LUBRICATORS	
Air Line	79
Air Line, Miniature	80
M.A.B., Pump Interchange	58
NIPPLES	72
PLUGS	72
PRESSURE WASHER HOSE	69
QUICK DISCONNECTS	69, 71
QUICK REFERENCES	
Airlessco Pump Kits	4
Airlessco Spray Guns	4, 76
Amspray Pump Components	58

ITEM	PAGE
QUICK REFERENCES, (continued)	
ASM Spray Guns	76
Binks Pump Components	7
Binks Spray Guns	7, 76
Devilbiss Spray Guns	14, 76
Glidden Pumps, Private Labeled by Amspray	17, 58
Glidden Pumps, Private Labeled by Wagner	17, 58-59
Glidden Pumps, Private Labeled by Airlessco	4, 17
Graco Pump Components	18-25
Graco Spray Guns	25, 76-77
H.E.R.O. Pump Components	45
Sharpe Spray Guns	76
Sherwin-Williams Pump Components	63
Speeflo Air Motors	49
Speeflo Pump Components	49
Speeflo Pump Models	48-49
Titan Spray Guns	50, 76-77
Titan Pump Components	50
Wagner Piston Pump Kits	59
Wagner Spray Guns	59, 77
REGULATORS	
Air Pressure	78
Air Pressure, Miniature	80
REPLACEMENT PARTS FOR...	
Airlessco	4-6
Amspray	60-63
ASM	6
Binks	7-14
Devilbiss	15-16
Glidden, Private Label Pumps	17
Graco	26-44
H.E.R.O.	46-47
Kremlin	57
Larius	57
Sharpe	47
Sherwin-Williams	63
Speeflo	51-56
Titan	51-56
Wagner	60-63
SHARPE	
Replacement Parts for	47
Spray Guns, Quick Reference	76
SHERWIN-WILLIAMS, Quick Reference	63
SINCLAIR, Pump Interchange	58
SPEEFLO	
Air Motor Kits, Quick Reference	49
Pump Components, Quick Reference	49
Pump Models, Quick Reference	48-49
Replacement Parts for	51-56
SPRAY GUN REPAIR KIT REFERENCES	
Airlessco	4, 76
Binks	7, 76
Devilbiss	14, 76
Graco	25, 76-77
Sharpe	76
Titan	50, 76-77
Wagner	59, 77
STRAINER BAGS, Paint	64
STRAINERS, Inlet	74
TITAN	
Pump Components, Quick Reference	48-50
Replacement Parts for	51-56
Spray Gun Kits, Quick Reference	50, 76-77
VALVES	
Air Metering, "Cheater"	67
Air Relief, Safety	81
Ball Valves	66-67
Dump Valves, High Pressure	66
WAGNER	
Amspray Pump Components, Quick Reference	58
Spray Guns, Quick Reference	59, 77
Piston Pump Kits, Quick Reference	58-59
Replacement Parts for	60-63

ORDER FORM



PAGE 2

NOTES

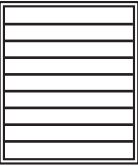

PAGE 3

PARTS FOR

AIRLESSCO

EQUIPMENT

PAGES 4-6

PARTS FOR

AMSPRAY
GLIDDEN
FULLER O'BRIEN
M.A.B.
SINCLAIR

EQUIPMENT

PAGES 58-63

PARTS FOR

ASM

EQUIPMENT

PAGE 6

PARTS FOR

BINKS

EQUIPMENT

PAGES 7-14

PARTS FOR

DEVILBISS

EQUIPMENT

PAGES 14-16

PARTS FOR

GLIDDEN

EQUIPMENT

PAGE 17

PARTS FOR

GRACO

EQUIPMENT

PAGES 18-44

PARTS FOR

H.E.R.O.

EQUIPMENT

PAGES 45-47

PARTS FOR

KREMLIN

EQUIPMENT

PAGE 57

PARTS FOR

LARIUS

EQUIPMENT

PAGE 57

PARTS FOR

SHARPE

EQUIPMENT

PAGE 47

PARTS FOR

SHERWIN-WILLIAMS

EQUIPMENT

PAGE 63

PARTS FOR

TITAN / SPEEFLO

EQUIPMENT

PAGES 48-56

PARTS FOR

WAGNER

EQUIPMENT

PAGES 58-63

PAINT STRAINERS



PAGE 64

DISPOSABLE CLOTHING

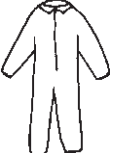

PAGE 64

TANK & CUP LID GASKETS

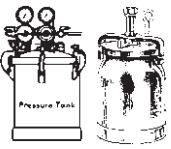

PAGE 65

VALVES

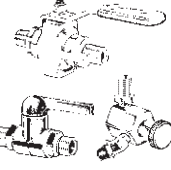

PAGES 66-67

HOSE & ASSEMBLIES

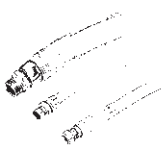

PAGES 68-70

FITTINGS & ADAPTERS

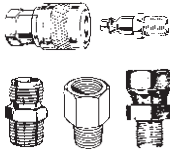

PAGES 68-73

FILTERS & STRAINERS

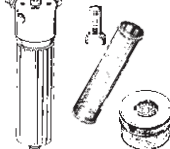

PAGES 73-75

SPRAY GUN REPAIR PARTS



PAGES 76-77

**To order, contact your local
Paint Spray Equipment Dealer and ask for
Genuine Bedford Replacement Parts.**

GAUGES

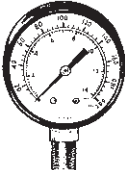

PAGE 78

AIR CONTROL COMPONENTS

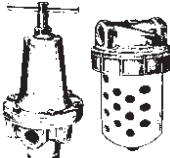

PAGES 78-81

RELIEF VALVES



PAGE 81

BEDFORD[®]
PRECISION PARTS CORP.

